



# Global Protocol on Packaging Sustainability 2.0

(c) 2011

A global project by



The Consumer Goods  
**FORUM**  
The Global Network Serving  
Shopper & Consumer Needs

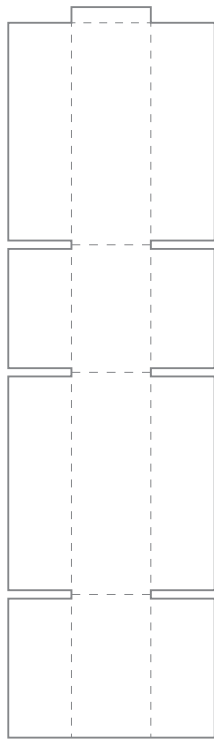



	<b>Guidance for Use – Introduction</b>	<b>6</b>
	A Common Language	6
	Range of Business Decisions	7
	<b>Choice of Indicators for Business Decisions</b>	<b>8</b>
	Relevance and Significance	8
	Life-Cycle Phases	8
	Parts of Business	8
	Role in Decision-Making	9
	Level at which Indicator is Utilized	9
	Alignment with other Objectives and Processes	9
	<b>Role in Communication</b>	<b>10</b>
	Internal vs. External Communication	10
	<b>Availability of Data</b>	<b>11</b>
	Physical Property Data	11
	Data for Driving Selected Indicator	11
	Linkages between Different Indicators	11
	<b>Types of Packaging</b>	<b>13</b>
	<b>Functional Unit, Functional Equivalence and Reference Flow</b>	<b>14</b>
	Choosing an Appropriate Functional Unit	14
	The Functional Unit in Packaging	15
	Primary & Secondary Functions and Functional Equivalence in Packaging	15
	Levels of Significance	16
	<b>Systematic Use of Life Cycle Assessment in Product Development</b>	
	<b>Guidance on Tools</b>	<b>17</b>
	Life Cycle Assessment	17
	Tools and Expertise	18
	Ecodesign Tools	19
	The Future of LCA in the FMCG Sector	20
	<b>GPPS Indicator and Metric Overview</b>	<b>21</b>
	<b>Environmental – Attribute Indicators / Metrics</b>	<b>22</b>
	Introduction	22
	Packaging Weight and Optimization	23
	Packaging to Product Weight Ratio	24
	Material Waste	24
	Recycled Content	25
	Renewable Content	26

27	Chain of Custody
27	Assessment and Minimization of Substances Hazardous to the Environment
28	Production Sites Located in Areas with Conditions of Water Stress or Scarcity
28	Packaging Reuse Rate
29	Packaging Recovery Rate
30	Cube Utilization
<b>34</b>	<b>Environmental – Life Cycle Indicators / Metrics</b>
34	Introduction to Life Cycle Assessment
<b>38</b>	<b>Impact on Climate / Atmosphere</b>
38	Global Warming Potential (GWP)
40	Ozone Depletion
<b>42</b>	<b>Impact on Human Health</b>
42	Toxicity, Cancer
43	Toxicity, Non-Cancer
44	Particulate Respiratory Effects
45	Ionizing Radiation
47	Photochemical Ozone Creation Potential (POCP)
<b>49</b>	<b>Impact on Ecosphere</b>
49	Acidification Potential
51	Aquatic Eutrophication
52	Freshwater Ecotoxicity Potential
<b>54</b>	<b>Impact on Resource Base</b>
54	Non-Renewable Resource Depletion
<b>57</b>	<b>Indicators from Inventory Data</b>
57	Introduction
57	Cumulative Energy Demand (CED)
59	Freshwater Consumption
62	Land Use
<b>68</b>	<b>Economic – Indicators / Metrics</b>
68	Introduction
68	Total Cost of Packaging
69	Packaged Product Wastage
<b>70</b>	<b>Social – Indicators / Metrics</b>
70	Introduction
70	Packaged Product Shelf Life
70	Community Investment
<b>71</b>	<b>Corporate Performance Attributes</b>
71	Instructions
73	Annex 1: Cube Utilization - Protocols for Product Volume (PV)

## Guidance for Use – Introduction

### A Common Language

The Global Protocol on Packaging Sustainability was created to provide the consumer goods and packaging industries with a much needed common language with which to discuss and assess the relative sustainability of packaging. That common language consists of a **framework** and a **measurement system**. The metrics presented in this report deliver the measurement system, which, alongside the framework, offer a standardised way to address a range of business questions about packaging sustainability, either within a company or between business partners.

You could consider these metrics to be the words in the language and this document as the dictionary. The framework provides the context for the language.

#### No need to use every metric

Just as it is not necessary to use every word in the dictionary in every conversation, so it is not necessary to use every metric in each discussion about the sustainability of packaging. The range of metrics aims to cover the full breadth of environmental and social aspects which may be needed to answer a range of business questions, but in each case the number and type of metrics used will depend on the business question being asked. Just as in the dictionary analogy, sometimes a single word conveys the message correctly and concisely; some business questions around packaging may just require a single metric. Similarly, just as some sentences need to be more complex and lengthy, broader assessments of packaging sustainability will require the use of a range of different metrics.

#### Economic and social metrics

A complete sustainability assessment should take into account economic, social and environmental aspects. Any business decision almost invariably includes an economic analysis, and environmental indicators are taken into account to an increasing extent, whereas social indicators are generally considered at a corporate level and are slowly being introduced as considerations at product level. The metrics proposed here include some, but not a full range of economic indicators. This is not because they are considered irrelevant, but because economic analysis tools already exist and are already routinely used. We encourage companies to follow prevailing corporate social responsibility guidelines and we have added two packaging-related social metrics for consideration. Social indicators for packaging as well as social life cycle assessment (S-LCA)<sup>1</sup> approaches are still in the early phase of development. We expect to be able to expand the selection of social metrics as this area of research progresses in the future.

#### Modular and flexible

The metrics described in this document can be put to use in many different ways. They can inform internal decision making, allow communication between business partners or with other stakeholders, or provide overall packaging system evaluations. The protocol is designed to allow this level of flexibility, but each different use for the protocol will have different implications for the selection of relevant metrics, the data required and how the results are used. This guidance aims to help the reader use the protocol appropriately for all of its potential applications.

<sup>1</sup>[http://www.uneptie.org/shared/publications/pdf/DTix1164xPA-guidelines\\_sLCA.pdf](http://www.uneptie.org/shared/publications/pdf/DTix1164xPA-guidelines_sLCA.pdf)

## Range of Business Decisions

The GPPS metrics can be used to answer a wide range of business questions, either within a business or between business partners. The business decisions these metrics address can vary greatly. The number and type of metrics used will depend on the business question being asked. A simple question about the weight or recycled content of specific packaging options will require the use of just one metric. By contrast, an overall assessment and comparison of entire product and packaging systems will require a lifecycle approach and the use of a wide range of metrics.

For example, one of the pilots shared during the GPPS development aimed to compare the overall sustainability performance of shelf-ready packaging with a normal packaging delivery system. Since an overall comparison was required, it was necessary to look at full life-cycle metrics for both environmental and social areas, and also to include an economic assessment.

Business decisions may be considered at a number of different levels:

**Level 1.** Simple analysis where, beyond cost considerations, a single indicator is sufficient to track a change, such as packaging weight, cube utilization, etc.

**Level 2.** Optimization analysis for a given functional unit (FU) where multiple indicators could be used in order to increase the environmental relevance as compared to using a single indicator. For example, using a weight reduction indicator together with a cube utilization indi-

cator to ensure that weight reductions aiming to reduce environmental impacts in transportation are not annihilated by a reduction in cube utilization. Another example would be to couple a recycled content indicator with an indicator of packaging weight to highlight potential environmental burden shifting between recycled content and packaging weight due to recycling-induced property losses.

**Level 3.** Comparative analysis of one or more packaging formats/material across multiple formats for same functional unit, such as comparing drink packs from glass, plastics, metal or beverage carton to see trade-offs with each material choice. In this case, life cycle assessment (LCA) may be required.

**Level 4.** Full system design and analysis that would compare packaging formats/materials with information on the product as well. This would involve a LCA that would incorporate elements of both the product and the packaging across the supply chain. In this case, various product factors or losses would need to be incorporated, such as use, waste, spoilage and damage.



## Choice of Indicators for Business Decisions

The indicators and metrics fall into three categories: Environmental, Economic and Social. In the Environmental area these metrics are divided into Attribute Indicators and Life Cycle Indicators. Choosing the indicators that are best for you depends on a number of factors including: what the business question is; what you are comparing, where in the packaging design process the assessments are being applied, how the results are being used and where in the supply chain they are being applied. There is no single formula or “right answer” in determining how many indicators or which indicators to use. Using only one or two indicators can answer a specific question, but may not give a clear (or complete) picture of actual impacts. In many cases a set of five to 10 indicators that clearly represent the company goals may be more appropriate (and easier to action) than a list of 40. The following six points should help you choose appropriate indicators, understanding that this is an ongoing process which will need to be revisited over time.

### Relevance and Significance

The selection of a particular metric depends on the business question being asked, and also often reflects an organization’s most significant areas of activity and influence. For example, a company working primarily with fiber-based packaging will select the metrics most pertinent to that material and ignore those that relate to other materials for processes. The selection may also be directly influenced by the severity of an issue in context, such as water scarcity in a particular locale. In a comparison of two pack-

aging alternatives, for example between an agro-sourced material and a fossil fuel-sourced material the set of metrics chosen for the comparison would have to be a combination of the relevant indicators of both materials in order to ensure that there is no shift of environmental burden between the compared alternatives. Taking into account the significance of impacts in absolute terms as well as the significance of differences observed is also crucial for good decision making.

### Life Cycle Phases

The adoption of packaging indicators by an organization should be consistent with life cycle thinking<sup>2</sup>. The life cycle indicators automatically incorporate the impacts from all phases of the packaging life cycle. In selecting packaging attributes, it is also useful to include attributes that address upstream, use phase, transportation, and end-of-life characteristics of the package. This helps facilitate life cycle thinking and consideration of each of these phases in tangible, familiar measures by packaging designers and others who influence packaging decisions.

### Parts of Business

An indicator may be more relevant to one part of a business than other parts of the business. For example, packaging reuse rate may be relevant in one region, but not relevant in another. A packaging manufacturer may have one division that uses entirely renewable materials, while other divisions use none.

<sup>2</sup> an approach in which all of the phases of the life-cycle are considered during decision-making, possibly but not necessarily involving the use of life-cycle assessment



### Role in Decision-Making

As with the adoption of any other metric, it is important to consider how the packaging indicator is intended to influence decision-making, as well as any unintended impacts it may have on decisions and incentives. In order to ensure that a metric informs the decision-making, it must at minimum be visible to and understood by the parties who influence decision-making. However, its impact can be augmented by assigning responsibilities related to the metric to those with the greatest ability to influence packaging decisions, taking into account the following factors:

### Level at which Indicator is Used

Throughout the process of selecting appropriate indicators, it is important to determine the level at which the indicator will be used. Many of the metrics could be assessed at packaging component or product level, at business unit level or at the corporate level. Some metrics may be used at one level for one purpose (e.g. managing the average percentage of recycled content in a product line) and then aggregated at a higher level (e.g. company-wide for CSR reporting). Keep in mind that the approach to data collection, availability of data, demands on data accuracy, and meaningful units of measurement may vary at each of these levels.

### Alignment with other Objectives and Processes

When adopting indicators and incorporating them into company policies and processes, it is helpful if the responsibility for measurement and tracking of metrics is in close proximity to the decision point and decision-maker. Indicators that are measured separately from other processes will generally have a lesser effect on decision-making and suffer a greater time lag until results are seen. For example, if a metric such as package to product weight ratio is adopted with the purpose of encouraging more efficient packaging design, then its measurement and the gathering of relevant data should ideally be done as part of the design or design-approval process. This way, designers and decision makers are aware of the metric at the time they are making the decisions that impact it. This embedded approach is more effective at giving the metric a role in decision making than assigning the data capture and metric calculation to someone else as part of a yearly reporting process.

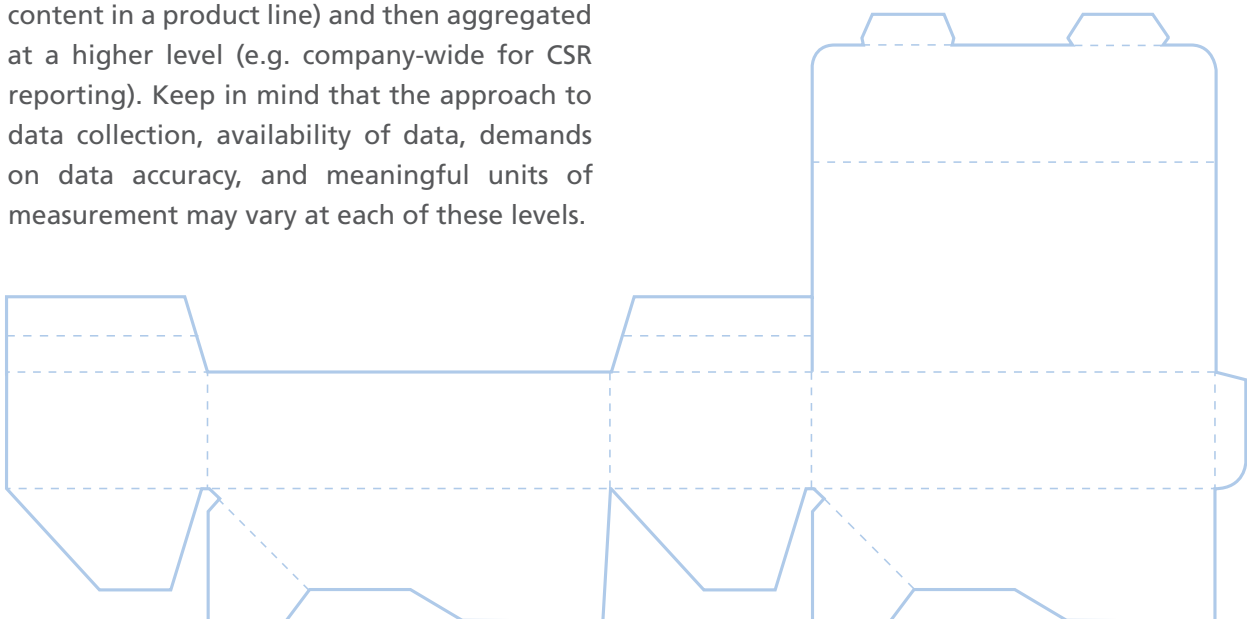

## Role in Communication

### Internal vs. External Communication

Understanding how the indicators will be used in communication will help in their selection. For example, are the indicators being used by marketing to show how a product package has been improved, or are they being used for corporate reporting to show some improvement over time, e.g. reduction of GHG per unit sold? If the indicators are being used in a decision-making process then it is also crucial that the audience be presented with clearly-stated goals in order to understand what is important for the company.

The use of indicators for external communications such as marketing claims or corporate reporting requires a greater level of accuracy, documentation and transparency of data than that which is required for tracking and communicating progress internally. Aggregate data may be suitable for internal use as long as the data gaps are not material and the limitations are adequately communicated. However, in such a case it is vital that the internal audience be made aware of the limited purpose and suitability of the data so that external claims are not made without proper substantiation. A set of packaging indicators adopted by an

organization may contain a mix of indicators intended for internal and external communication. In addition, some indicators may warrant different metrics for different audiences. For example, the package-to-product ratio may be relevant for both internal and external audiences. However, note that even for a single indicator, the specific metric and functional unit that will be meaningful may differ depending on the audience.

Note that specific guidance is given within ISO 14040/44 for life cycle assessment based comparative assertions to be disclosed to the Public. For declarations, labels and claims provisions are available in, e.g. ISO 14021 or the FTC Guidelines on environmental marketing claims (FTC 260). This protocol is not intended to replace any of the existing standards and guidelines which still need to be adhered to in any external communication related to sustainability performance of packaging and products.

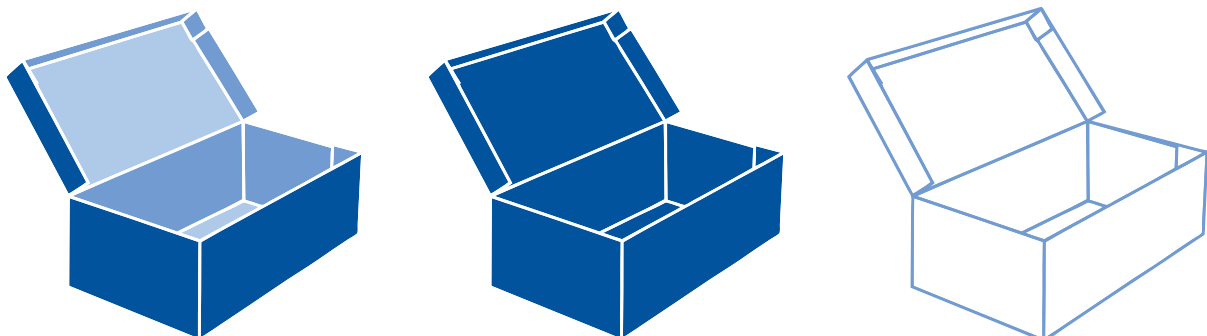

## Availability of Data

An indicator is only as good as its data. Having sufficient data is therefore essential when selecting indicators. The availability of data and of resources to obtain the necessary data will impact the number of metrics that can feasibly be adopted and the value of the metrics themselves. There are two categories of data: physical property data a company has on each packaging component as well as the product itself (readily available data or obtained from your supply chain) and data that is used to drive selected indicators (mainly in streamlined LCA tools). The source of the data that you use should be documented for each metric.

### Physical Property Data

Each indicator has different data needs (component weight, material type, product size or volume, country of origin, etc). Some of these data may already be in a company's specification/ERP system or may require collection from the supply chain. This may not be a limiting factor for a one-time analysis, but may be a factor if you are reviewing a company's improvement over time or requiring the indicator's use for all new product development. If the indicator is important for one of the reasons stated above, the company may want to begin collecting this data for future use.

### Data for Deriving Selected Indicators

Many indicators (and the tools that use them) require background data based on LCA material and process data. These are then used to drive the analysis. For example, many streamlined LCA tools use data that estimate the GHG,

energy use or other impacts based on detailed LCA studies. In many cases there may not be sufficient data on the specific life cycle under focus; or the data in the tool may not have the capability to discern variations in factors such as recycled content. Other indicators may be important to you but may need additional work or time before they can be of value. A good example of this could be the Fresh Water Used from Stressed or Scarce Sources indicator. This particular indicator/metric may be important to your company but the mapping of these stressed source areas is not developed at this time; however, it may be appropriate to use at a later date.

### Linkages between Different Indicators

The metrics presented in this report are not all independent. In some cases there is a link between two separate indicators, or alternatively, the same data may be used to calculate different metrics. For example, if the metric "Packaging to product weight ratio" is calculated, then the metric "Packaging Weight" will also have been calculated, and little effort would be needed to additionally calculate "Packaging weight reduction". If any of the lifecycle indicators are calculated, this would have required collection of the data for many of the packaging attribute indicators. This means that it is often not as onerous as first thought to calculate a given range of metrics.

Figure 1 will help the user understand the amount of work that will be needed to calculate the different indicators.

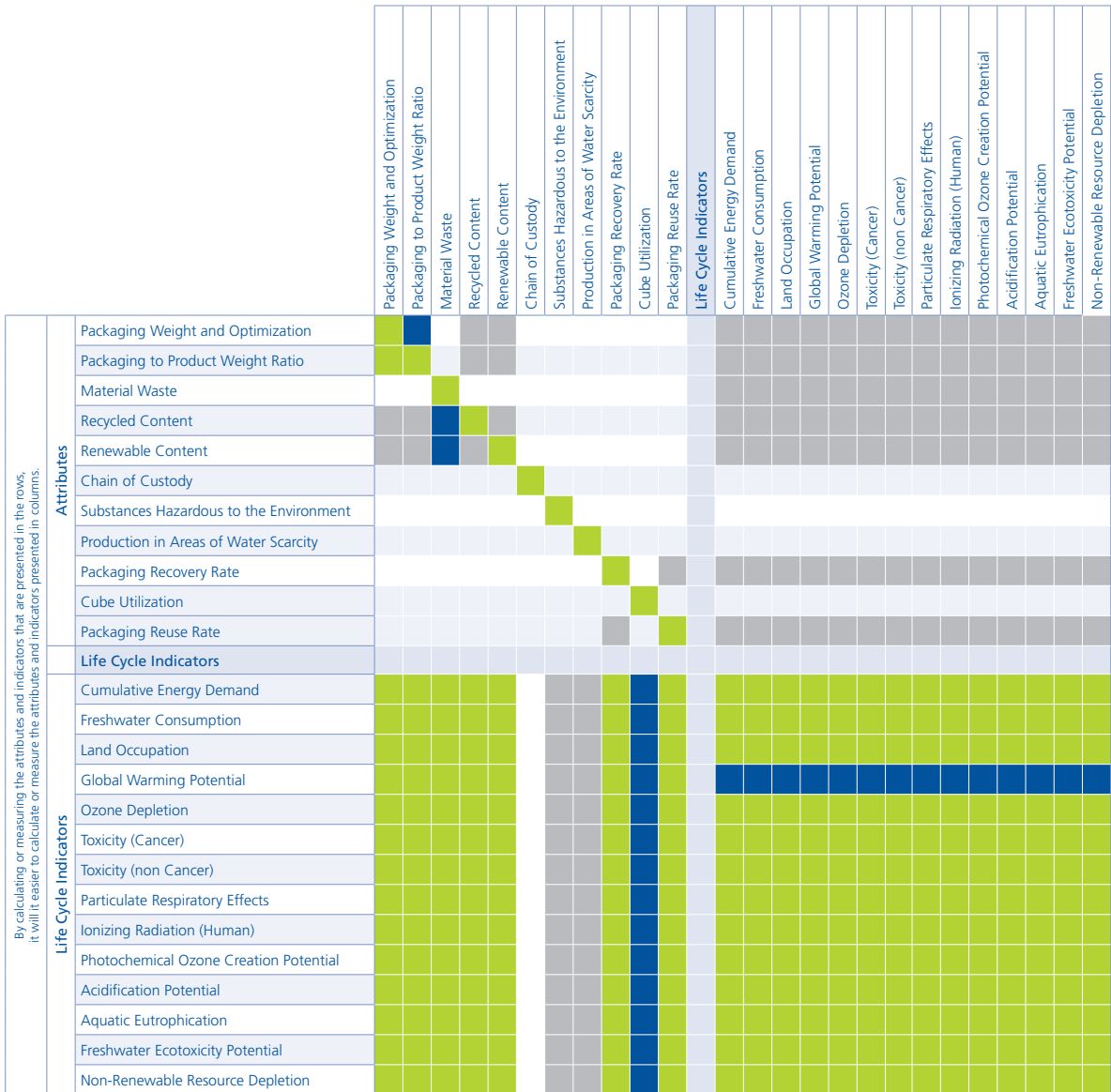

is automatically derived
  will likely be derived
  will help to derive

Figure 1. There are sometimes strong synergies between the different indicators. This figure shows how the different indicators are related. The colours in the boxes show the degree of relatedness between the calculated indicators (shown in the rows) to the other indicators (shown across the top of the columns). If the box is green, then the other indicator will have been calculated as well, automatically. Blue boxes show other metrics that will likely have been calculated as well. Light grey boxes denote where calculation of the indicator in the row will at least help in calculation of the other indicator in the column.

## Types of Packaging

Figure 2 describes some commonly used definitions of types of packaging used in the value chain. The concepts of primary, secondary and tertiary packaging are standardized in ISO CD 18601. Sales packaging is also a term which is frequently used. *The use of several terms may be required in order to provide an exhaustive description allowing the determination of where the packaging item in question will be discarded and made available to recovery operators.*

Selecting the optimum balance among these three levels of packaging is a critical element in packaging design.

is designed to ensure damage-free handling and transport of a number of sales or grouped packages. The term “transport packaging” does not include road, rail, ship or air containers. Transport packaging is normally a shipping unit such as an outer case, a pallet, or a crate.

**Sales Packaging** is packaging with which the consumer leaves a store. Depending on the location and type of retail activity, sales packaging can be composed of one or several levels of packaging.

The following additional terms are also frequently used to describe packaging levels:

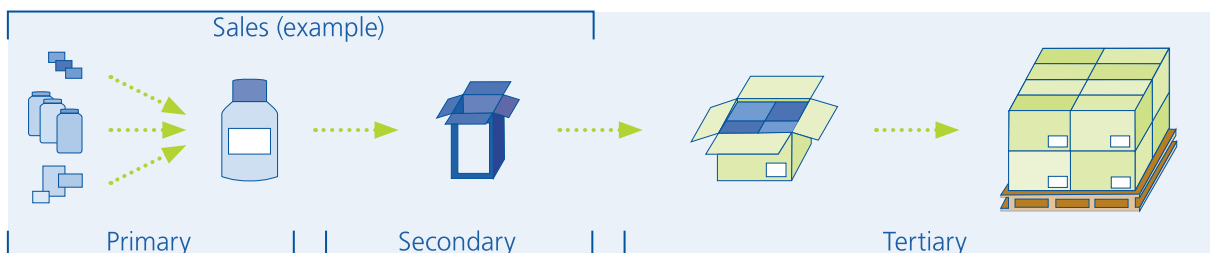

Figure 2. Common terms used to describe packaging types.

**Primary Packaging** constitutes the packaging designed to come into direct contact with the product.

**Secondary Packaging** (or group packaging) groups a given number of primary packaging units together into a convenient unit at the point of sale. Secondary packaging typically has one of two roles: it can be a convenient means to replenish the shelves; or it can group primary packaging units into a package for purchase. It can be removed without affecting the product’s properties, and generally defines the unit handled by the retailer.

**Tertiary Packaging** (or transport packaging)

**Packaging constituent:** a packaging element that cannot be easily separated from the rest of the packaging (EN 13427, ISO/CD 18601), for example, a sealing layer in a laminated film.

**Packaging component:** part of packaging that can be separated by hand or by using simple physical means (EN 13427, ISO/CD 18601), for example, a packaging film.

**Packaging system:** the complete set of packaging for a given product, encompassing one or more of primary, secondary and transport tertiary packaging depending on the packed product (ISO/CD 18601).

## Functional Unit, Functional Equivalence and Reference Flow<sup>3</sup>

Life cycle assessment (LCA) is a methodology that evaluates the potential impact of the use of a product by parsing its function. The functional unit characterizes this function by naming and quantifying the qualitative and quantitative aspects of the function(s) through questions such as “what”, “how much”, “how well”, and “for how long”. It is the unit to

which all environmental impacts of a given study are reported. It is also the unit driving the data collection process. A reference flow is a quantified amount of the product(s), including product parts, necessary for a specific product system to deliver the performance described by the functional unit. A functional unit may have several reference flows.

Product	Function	Functional unit	Reference flow
Car	Enabling people to travel	One person traveling 100 km	Passenger car A consuming x L of petrol / 100 km
Shoes	Protecting foot	Protect one foot during 500 km of walking	1 pair of dedicated walking shoes or 2 pairs of standard shoes
Packaging	Protect product	Protect 100g of products until being on the table of the consumer	Required primary, secondary & tertiary packaging to deliver adequate protection for a specified distribution system.
Light bulb	Illuminate	Lighting 10 square meters with 3000 lux for 50000 hours with daylight spectrum at 5600 K	15 daylight bulbs of 10000 lumen with a lifetime of 10000 hours.

Table 1. Examples of functions, functional units and reference flows in Life Cycle Assessment.

### Choosing an Appropriate Functional Unit

A well defined functional unit allows comparison of two essentially different systems or products on an equivalent basis. *The functional unit is just as important for comparisons made using attribute metrics, such as packaging weight, as it is in LCA.* For example, if a comparison of packaging weights of a concentrated product and a non-concentrated one is based on a functional unit defined as “protect 1kg of product from factory to consumer”, the concentrated product will be disadvantaged as the true function of the product is not taken into account. A more appropriate functional unit would in

this case be based on the delivery of a certain number of uses in the case of a detergent or number of servings in the case of foodstuffs, thus better reflecting the service provided to the consumer.

In the case of paint, an ill-defined functional unit would be 1 m<sup>2</sup> covered, as this only compares the capability of the compared paints to cover a surface but says nothing about how long the paint will protect the surface and thus nothing about how much paint will be required over an extended period of time. A more reasonable

<sup>3</sup> More details can be found in ISO 14040/44

functional unit for a paint system would be 1 m<sup>2</sup> adequately protected for 10 years. Such a functional unit allows taking into account the increased quantities of less durable paint that would be required to re-paint a surface.

### The Functional Unit in Packaging

In the case of packaging, which is intimately connected with the product contained, it is important that the functional unit reflects the packaging performance required with respect to the packaged product. This might include: required strength of the packaging, required protection during transportation, preserving the quality of foodstuffs, protection against light penetration, prevention of residue production etc. You may also need to consider legal requirements in relation to the packaged product (e.g. foodstuffs), and the performance of the packaging in relation to machinery.

The functional unit will change along the value chain. A typical packaging functional unit for a brand owner or a retailer would be to fulfill packaging functions for 100g of product from factory to consumer. For a converter supplying packaging film to a customer, the functional unit could be surface area in square meters of a film with a specified performance delivered

to the customer. For a material supplier the functional unit typically equals the reference flow, e.g. in case of a plastic pellet provider the appropriate reference flow is kg of pellets delivered to the converter.

### Primary & Secondary Functions and Functional Equivalence in Packaging

A product or packaging can have different functions (primary and secondary functions). What all packaging has in common is that it enables delivery of a given quantity of product from a producer to a customer or a consumer. Therefore, “contain and protect” is the primary function of packaging. There is a multitude of secondary functions of packaging: it might offer convenient handling, aid storage and use with open- and re-close features, it may be recyclable or recoverable, or reinforce the brand experience with appearance. When comparing scenarios it is crucial to make sure that primary functions are the same and that secondary functions are as similar as possible. *The functional equivalence forms the basis for any comparison in LCA.*

The more functions two packaging alternatives have in common the more meaningful it becomes to attempt direct comparisons.

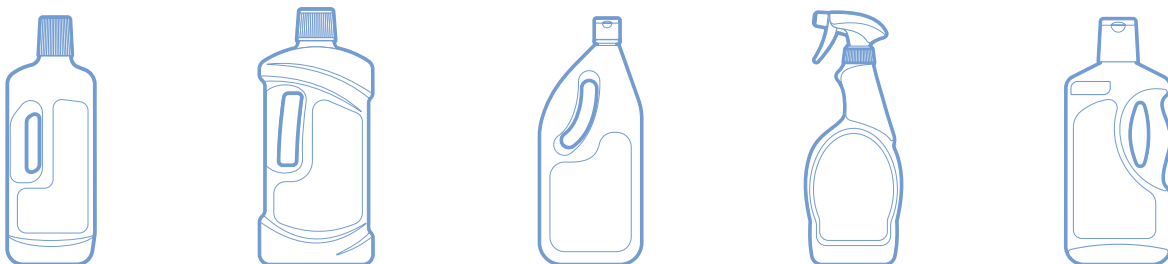

### Levels of Significance

The metrics proposed in this protocol are - even in the case of life cycle assessment indicators - only attempts to estimate "the true" environmental consequences by estimating potential impacts. Nevertheless, such estimates are very useful to improve decision making with the intention of improving sustainability performance of packaging and other products just as economic models are useful to estimate financial impacts and benefits. As with any comparison of estimates, it is important to understand the uncertainty involved in the calculation of the metrics, and the significance of any differences observed with respect to uncertainty. The accuracy of a result will vary depending on the type of metrics used and the types of uncertainty involved. With simple metrics, such as packaging weight, the level of accuracy will simply reflect the accuracy of the measurement tools employed. However, in the more complex life-cycle metrics, the result is a calculation based on a model rather than a direct measurement, and will depend on the accuracy and relevance of the data employed in the model as well as the accuracy of the model itself. This will give a larger margin of error in the final result, so comparisons between different systems should be made with caution taking uncertainty into account. LCA practitioners often use a rule of

thumb that differences in LCA metrics such as climate change or energy consumption of less than 10% should not be considered significant as long as the differences of compared alternatives are not one-directional. More sophisticated uncertainty analysis methods are required with other metrics, such as those relating to toxicity impacts. While this may seem limiting, it often allows identification of clear and unambiguous differences between packaging options as well as the identification of potential hot-spots in a studied packaging system. As an analogy, while LCA will distinguish chalk from cheese, it will not tell Brie from Camembert!





## Systematic Use of Life Cycle Assessment in Product Development – Guidance on Tools

Historically the packaging industry has accounted for the environmental impacts of packaging through attributes such as packaging weight reduction, recycled content, and recovery rates of used packaging. Although such indicators are relatively easy to measure, they are not directly related to environmental impacts; rather, they are input information to estimate environmental impacts. A reduced or increased attribute value may or may not lead to reduced environmental impacts.

**Example:** design guidelines for packaging weight reduction would encourage a designer to combine materials in multilayer structures efficiently combining strengths of individual materials in order to save packaging weight. Such guidelines are in direct conflict with guidelines on recyclability, which would call for use of a single material in a packaging format which is easily identified, separated and recycled. While a gauge reduction of one material, provided that physical performance is conserved, will most certainly lead to an improvement of environmental performance, the same gauge reduction achieved by a switch to another material does not automatically translate into improved environmental performance.

Using such environmental attributes is thus not sufficient for companies seeking to continuously reduce packaging environmental impacts as they are limited to answering very specific questions. A decision support tool giving feedback to the designer on the environmental consequences of decisions taken in the packaging development process over the entire packaging life cycle is therefore required.

### Life Cycle Assessment

The appropriate tool for considering environmental impacts over the packaging life cycle is life cycle assessment (LCA). LCA can be performed at different levels depending on the type of questions being asked, the purpose of the study, or the state of development of a new product or a new packaging. The work to perform a LCA can range from a couple of hours to more than 100 days of work. Practitioners generally classify LCAs in two different categories in terms of level of detail: simplified, streamlined or screening LCAs and comprehensive, detailed or full LCA. LCA tools can also be separated into two major classes: highly flexible conventional LCA software and tailored and rapid Ecodesign tools with a lower degree of flexibility (Table 2).

Type of LCA tool	Strengths	Weaknesses	Application
Ecodesign	Quick, low cost, consistent, can be used by non-experts	Low flexibility No capacity to capture specificities Limited possibility to support environmental claims	Design process, environmental information, well suited for non-expert in a well-framed process
Conventional	Robustness, flexibility Can support marketing claims after external peer review	More costly and long, requires expert knowledge	Internal evaluation of a product and comparison with alternatives To support marketing claims about the environmental impact of a product

Table 2. Types of LCA tools and area of application as a function of strength and weakness.

### Conventional LCA Tools

Comprehensive LCA's are performed using conventional software packages where the user will go through the full procedure of goal and scope definition, inventory assessment, impact assessment and interpretation. A wide range of LCA tools are available for this purpose (1). Conventional LCA tools allow for flexibility on all levels of a LCA. This flexibility also contributes to some of their draw-backs: they require considerable expertise and are laborious and costly. Few companies can afford to employ in-house LCA expertise, let alone systematically use LCA to support decision making in product development. As a consequence, many studies are outsourced to LCA consultants. Although such an approach is feasible for companies with products that do not change frequently, it is not an efficient approach for the fast-moving

consumer goods (FMCG) sector where systematic product assessment using conventional LCA tools for all product developments would generate excessively high costs. Nor is it an economically viable solution for small and medium sized enterprises (SMEs). In addition to this the time required to complete a conventional LCA study is such that results are frequently obtained at the end of the packaging development when a product is ready to be launched. At this late stage, the freedom for change has been reduced to a minimum and the cost for change is at its maximum (Figure 3). Life cycle assessment results thus become at best a strategic tool for future improvement of the packaging life cycle or at worst an expensive way of documenting success or failure.

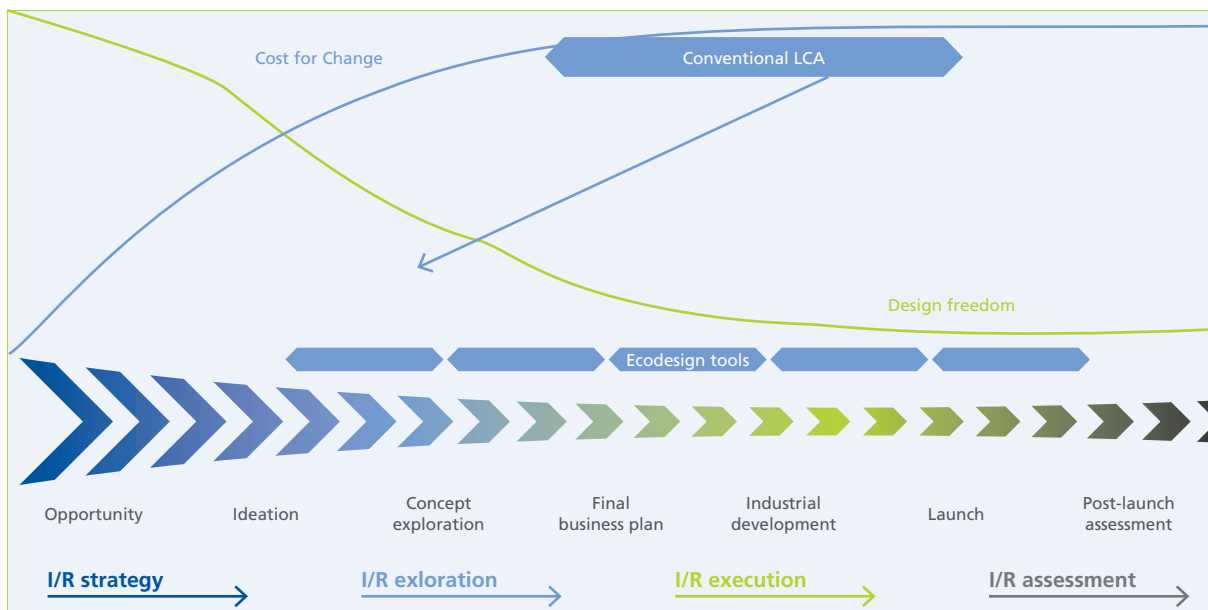

Figure 3. Evolution of cost for change and freedom of change in the innovation process<sup>4</sup>.

<sup>4</sup> Lundquist, L., *The role of environmental impact assessment at Nestlé*, The Role of Impact Assessment in Transitioning to a Green Economy, International Association for Impact Assessment 30<sup>th</sup> Annual Conference, Geneva, Switzerland, April 7, 2010 (Reproduced with permission).

## Ecodesign Tools

There is thus a rationale for simplified and tailored LCA-based tools which open LCA to non-experts, allowing rapid assessment of environmental consequences of design decisions already at the concept stage. The vast amount of LCAs performed in the past affords an understanding of where the hot-spots are in the packaging value chain. This understanding lays the foundation for efficient streamlining and automation of LCA. Various sector-specific tools have been developed or are currently being developed; these tools are publicly available (2,3). Many value chain operators have also developed in-house tools adapted to specific company needs. Such tools aim to preserve the integrity of the LCA approach in highlighting environmental issues at each life stage, while doing so more quickly and cheaply. The commonality between streamlined automated tools, or ecodesign tools as they may also be called, is that many of the LCA steps requiring considerable expertise have been pre-defined for the user and the interface emulates the development process prompting a packaging developer only for inputs with which she or he works on a daily basis. Typically, ecodesign tools have the following features pre-defined: functional unit, system borders, inventory data for materials and processes, including recovery and disposal operations, and impact assessment methods. Frequently such tools also combine life cycle environmental impacts, such as global warming potential, with packaging-specific environmental attributes such as packaging-to-product weight ratio, recycled content, fraction of recyclable material and so on, thus offering the

packaging developer a comprehensive assessment of the packaging format being assessed.

Whereas both tool types require the same level of expertise with respect to interpretation of results, the advantage of ecodesign tools is their relative simplicity and user-friendliness as well as the speed of assessment. LCA results obtained using the same tool will be more consistent than comparisons of LCA studies using conventional LCA tools since the same methodology, hypotheses and data are used for all studies. The disadvantage of ecodesign tools is the fact that although they might be more consistent they are not more precise or reliable than a comprehensive LCA generated with conventional LCA software. They will especially encounter limits as soon as the product or packaging to study falls out of the scope defined for the tool. Nevertheless, they constitute an affordable and practical compromise between the use of simple environmental attributes and conventional LCA software, thus providing a better base for decision-making in the FMCG sector. A combination of ecodesign tools and expert work using conventional LCA software provides a very good basis to tackle most of the issues regarding packaging and sustainability within a company.

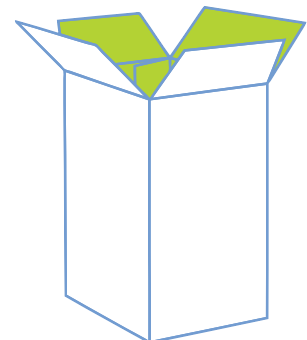

## The Future of LCA in the FMCG Sector

LCA is becoming an integral part of the industrial decision-making process. It is used, for example, to make tactical decisions in product and process design or improvement, or as a support for strategy, or in supply chain management and procurement. The increased use of LCA has boosted demand for streamlined and tailor-made LCA-based tools. This demand will certainly give rise to the development of a wide variety of tools, which once integrated or interlinked with existing management tools will be capable of providing different levels of information for different users.

In most cases, ecodesign tools do not constitute a replacement of conventional LCA for environmental claims made to third parties; the requirements for this kind of communication

are much stricter. However, they are very useful for informed internal decision making in the development process as well as for business-to-business communication. Needless to say, LCA-based claims and comparative assertions made to third parties should comply with the requirements stipulated in ISO 14040 and 14044, regardless of the LCA tool used to generate the results of the claim. It is our hope that the alignment achieved in this project will pave the way to a further alignment of ecodesign tools so as to facilitate LCA-based information exchange between partners of the packaging value chain. They will thus allow not only individual value chain members to meet their environmental objectives more efficiently, but also allow the entire packaging value chain to do the same.

## References

1. European Commission - Joint Research Center. Site on LCA Tools and Services. EUROPA. [En ligne] [Citation : 12 01 2011.] <http://lca.jrc.ec.europa.eu/lcainfohub/toolList.vm>.
2. COMPASS - Comparative Packaging Assessment. [En ligne] Sustainable Packaging Coalition. <https://www.design-compass.org/>.
3. Sustainable Packaging Alliance. PIQET Log-in. [En ligne] Sustainable Packaging Alliance. <http://piqet.sustainablepack.org/login.php>.

## GPPS Indicator and Metric Overview

ENVIRONMENTAL ATTRIBUTES & LIFE CYCLE INDICATORS	
ATTRIBUTES	
Packaging Weight and Optimization	Assessment and Minimization of Substances Hazardous to the Environment
Packaging to Product Weight Ratio	Production Sites Located in Areas with Conditions of Water Stress or Scarcity
Material Waste	Packaging Reuse Rate
Recycled Content	Packaging Recovery Rate
Renewable Content	Cube Utilization
Chain of Custody	
LIFE CYCLE INDICATORS – INVENTORY	
Cumulative Energy Demand	Land Use
Fresh Water Consumption	
LIFE CYCLE INDICATORS – IMPACT CATEGORIES	
Global Warming Potential	Photochemical ozone creation potential (POCP)
Ozone Depletion	Acidification Potential
Toxicity, Cancer	Aquatic Eutrophication
Toxicity, Non-Cancer	Freshwater Ecotoxicity Potential
Particulate Respiratory Effects	Non-Renewable Resource Depletion
Ionizing Radiation (Human)	
ECONOMIC & SOCIAL ATTRIBUTES	
ECONOMIC	
Total Cost of Packaging	Packaged Product Wastage
SOCIAL	
Packaged Product Shelf-Life	Community Investment
CORPORATE PERFORMANCE CHECKLIST	
ENVIRONMENT	
Environmental Management System	Energy Audits
SOCIAL	
Child Labor	Freedom of Association and/or Collective Bargaining
Excessive Working Hours	Occupational Health
Responsible Workplace Practices	Discrimination
Forced or Compulsory Labor	Safety Performance Standards
Remuneration	

## Environmental – Attribute Indicators / Metrics

### Introduction

An attribute is an indicator that provides partial and/or indirect information with respect to the environmental performance of packaging across its life cycle. An attribute can provide quantitative or qualitative information about an individual life cycle step or operation in the packaging life cycle or a qualitative piece of information related to the management of operations or the supply chain. Many attributes are indispensable pieces of information required for the preparation of a comprehensive life cycle assessment of packaging.

It is important to note that attributes provide information, but not assessment. They do not necessarily indicate positive or negative environmental consequences and have to be used in connection with life cycle indicators and other attributes. Their validity depends on the specific case at hand. Not all metrics are valid for all applications.

Generally these metrics have to be used and interpreted depending on the specific business case to be supported.

Several of the environmental attributes are based on ISO standards and European Standards (EN 13427 – 13432), depicted in Figure 4, linked to the European Packaging and Packaging Waste Directive which are currently serving as a base for work within ISO on standards for packaging and the environment. A Guide to using these standards has been published by EUROPEN, The European Organization for Packaging and Environment ([www.europen.be](http://www.europen.be)).

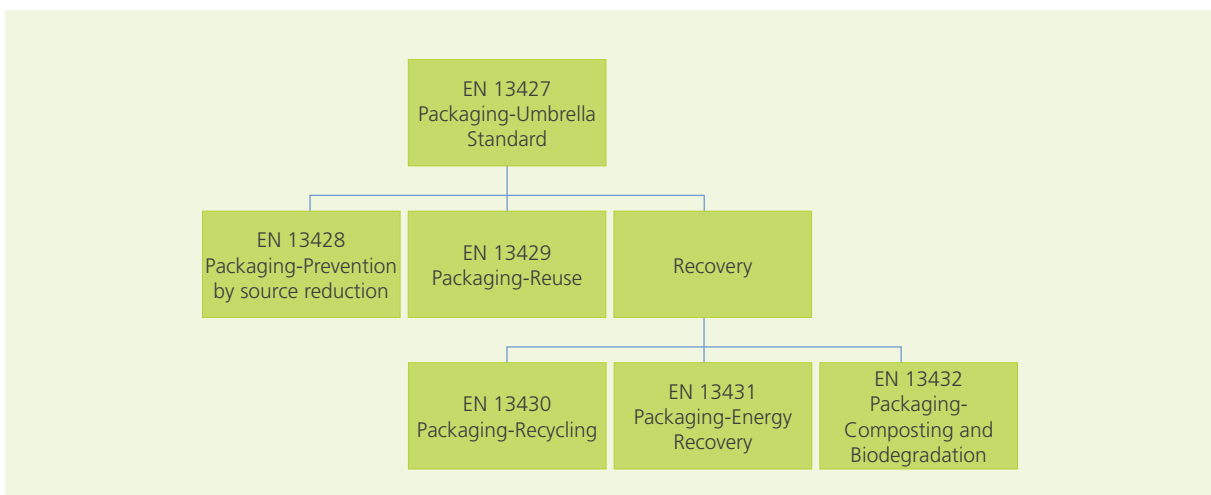

Figure 4. The EN Suite of standards supporting the European Parliament and Council Directive on Packaging and Packaging Waste [94/62/EC].

## Packaging Weight and Optimization

Includes Primary, Secondary and Tertiary Packaging

### Definition

The weight and identity of a packaging constituent, component or system which changes hands in the supply chain and demonstration that the packaging has been optimized by weight or volume in accordance with EN 13428 or ISO/CD 18602, once finalized.

### Metric

Weight per packaging constituent, component or system and demonstration of optimization as described by EN 13428 or ISO/CD 18602 once finalized.

### Examples

1. Proof of minimum adequate packaging weight
  - (yes / no)
2. Packaging weight
  - Kilograms / packaging constituent, component, or system



### What to Measure

**Packaging Weight:** Determine the weight of packaging constituents, components or packaging systems which change hands in the packaging supply chain. As per EN13428 and/or ISO/CD18602 (once finalized) determine and substantiate the single performance criterion that prevents further reduction in quantity (weight or volume) of the materials used. Performance criteria include: product protection, packaging manufacturing process, packing/filling process, logistics, product presentation and marketing, user/consumer acceptance, information, safety, legislation and, other (specify).

**Communicating Packaging Weight Reduction:** Packaging weight reduction can be calculated as the difference between the immediate previous and present packaging design. For environmental relevance, packaging weight reduction should be communicated by material category. In cases where a weight reduction is achieved at the expense of a weight increase in another material category in the same packaging component or in another part of the packaging system, for example an increase of secondary packaging, this should be clearly communicated and the increase quantified.

### What Not to Measure

N/A

## Packaging to Product Weight Ratio

### Definition

The ratio of the weight of all packaging material used to the weight of the product or functional unit delivered.

### Metric

Weight of all packaging components used in the packaging system per functional unit.

### Examples

- Packaging weight (kg) / FU

### What to Measure

Calculate the total weight of the packaging components used in the packaging system according to the protocol for Packaging Weight and Optimization. Determine the ratio to the mass of product or amount of product service delivered per functional unit. This measurement should take all components in a packaging system into account in order to avoid hiding the shifting of weight between packaging levels, i.e., between primary, secondary and tertiary packaging. Comparisons of packaging to product weight ratios for an incomplete packaging system, i.e. primary or primary and secondary packaging is only justified if the packaging levels left out of scope remain identical.

### What Not to Measure

N/A

## Material Waste

### Definition

The mass of material waste generated during the production and transport of packaging materials, packaging constituents, packaging components or packaging systems.

### Metric

Mass per packaging constituent, packaging component, or packaging system.

### Examples

- Kilograms / FU

### What to Measure

Only measure material destined for landfill and final disposal. Measurement should include the scrap, unwanted surplus material, unwanted by-products and broken, contaminated or otherwise spoiled material associated with the conversion of packaging materials into packaging components, assembly of packaging components into units of packaging, filling of packaging units and the transport of packaging materials, packaging components, units of packaging or packaging systems. Note that this is an operational parameter which can be measured by any individual operator within the supply chain as a measure of operational efficiency. Such information can be communicated between two parties in the supply chain to demonstrate operational efficiency, but the metric is not suitable, nor intended, to be cumulated across the entire supply chain.

### What Not to Measure

Do not report materials which are reused or recycled.



### Recycled Content

#### Definition

The ratio of recycled material (post-consumer and pre-consumer as defined by ISO 14021) to total material used in packaging constituents, packaging components, or packaging systems.

#### Metric

Percent recycled material of total quantity of material used per packaging constituent, packaging component or packaging system. Pre-consumer and post-consumer recycled content can be calculated separately to provide a greater level of detail

#### Examples

- % recycled content / packaging constituent, component, or system

#### What to Measure

Measure post-consumer recycled material and pre-consumer as per ISO 14021. For additional guidance, refer to ISO 14021.

#### What Not to Measure

N/A

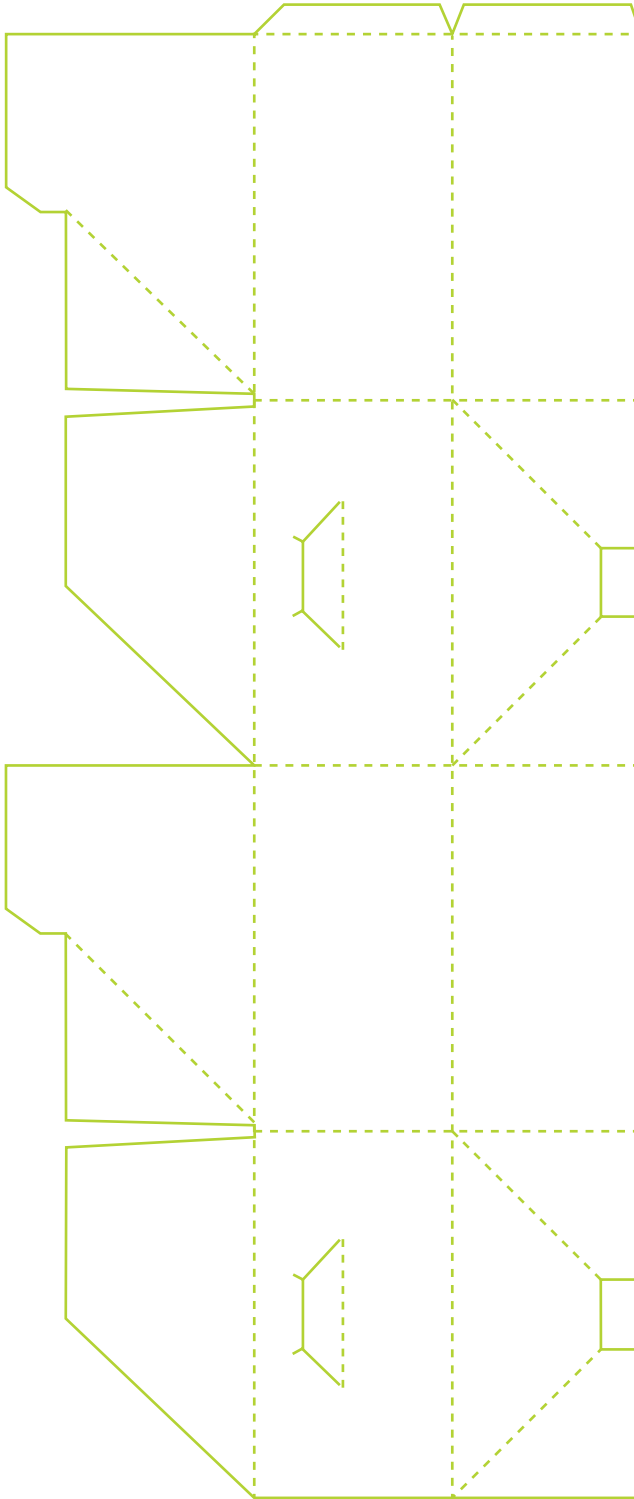

## Renewable Content

### Definition

The ratio of renewable material used to total material used in packaging constituents, components, units of packaging or packaging systems.

**Note 1:** Renewable material is material that is composed of biomass from a living source and that can be continually replenished. To be defined as renewable, virgin materials shall come from sources which are replenished at a rate equal to or greater than the rate of depletion. Biomass is defined as material of biological origin excluding material embedded in geological formations or transformed to fossilized material and excluding peat. This includes organic material (both living and dead) from above and below ground, e.g. trees, crops, grasses, tree litter, algae, animals and waste of biological origin, e.g. manure.

**Note 2:** the above definitions are taken from the text of the final draft amendment to ISO 14021 which is due for publication in the near future.

The renewable content can be defined on two levels:

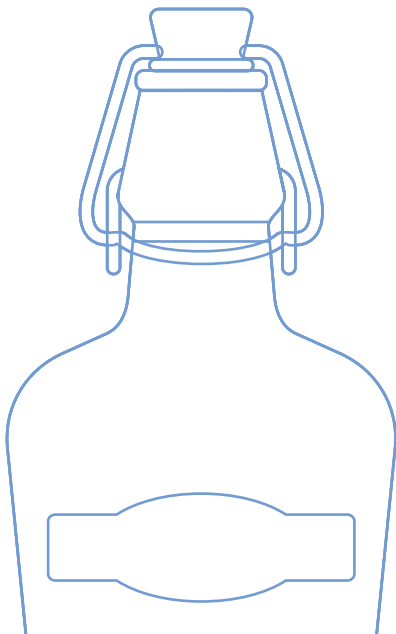

- **Material level:** The renewable material content is the percentage of renewable material of the total material used in packaging constituents, components, units of packaging or packaging systems.
- **Carbon level:** The renewable carbon content is the percentage of renewable carbon of the total carbon in packaging constituents, components, units of packaging or packaging systems.

### Metric

- The percent by weight on material level according to the amendment to ISO 14021.
- The percent by weight on carbon level according to ASTM D6866. This metric shall be applied when the source of the material (renewable or non-renewable) is unknown.

### Examples

- % of total material weight / packaging constituent, component, or system
- % renewable carbon to total carbon / packaging constituent, component, or system

### What to Measure

Measure renewable content either as percent by weight of total material used or as percent renewable carbon of total carbon.

### What Not to Measure

NA

## Chain of Custody

### Definition

The linked set of organizations, from point of harvest or extraction to point of purchase, that have held legal ownership or physical control of raw materials or recycled materials, used in packaging constituents, packaging components, or packaging systems.

### Metric

Unknown, known or sourced-certified.

### Examples

N/A

### What to Measure

Chain of custody is measured in order to ensure reliability, performance and transparency in the supply chain. The chain of custody will be deemed “known” if each party in the supply chain is under contractual obligation and is able to disclose proof of their material source(s) through purchasing agreements, inventory records, etc. For additional guidance, refer to any relevant source certification system protocols, such as the Forest Stewardship Council (FSC) guidelines, Sustainable Forestry Initiative (SFI) and Programme for Endorsement of Forest Certification (PEFC). Although at this time certification schemes exist primarily for forestry, this metric can apply to any raw material used for packaging. Several initiatives are underway to establish chain of custody systems for other materials.

### What not to Measure

N/A

## Assessment and Minimization of Substances Hazardous to the Environment

### Definition

Assessment and minimization of substances, or mixtures, hazardous to the environment in packaging constituents, components, or systems that are at risk of entering the environment.

### Metric

Meeting the requirements of EN 13428 or ISO 18602 (when published) on heavy metals and dangerous/hazardous substances.

### Examples

Statement that the relevant requirements of the standard have been met.

### What to Measure

The assessment should include substances classified as presenting an environmental hazard according to the UN Globally Harmonized System for Classification and Labelling of Chemicals and its amendments and meeting the criteria of labelling with the environmental hazard pictogram. Or for those following EN13428, EU substances included in the EU “N” List. For additional guidance, refer to standards ISO 18602 (currently a CD), EN 13427:2004, EN 13428:2004; CEN CR 13695-1:2004 and CEN CR 13695-2:2004 and any other relevant legal lists that apply to any specific region.

### What Not to Measure

Substances or mixtures used within the manufacturing or converting process but not present in packaging.

## Production Sites Located in Areas with Conditions of Water Stress or Scarcity

### Definition

The number of facilities involved with the production of packaging materials (including recycled materials), packaging constituents, packaging components or units of packaging and/or filling and sealing of units of packaging that operate in areas identified as stressed or scarce fresh water resource area.

### Metric

- Number (or percent of facilities owned by a single operator) located in an area identified as a stressed or scarce water resource area. The approach or tool used to determine water stress or scarcity should be identified.

### Examples

Single sites: Yes, no, not applicable

Multiple sites: Yes (percent of facilities in said areas), no, not applicable

### What to Measure

Use the Global Water Tool<sup>5</sup> or ETH Water Scarcity Index<sup>6</sup> to identify if a site involved in the production of packaging materials (including recycled materials) packaging components or units of packaging and/or filling and sealing of units is located in an area of stressed or scarce water resources in terms of fresh water consumption versus fresh water availability.

### What Not to Measure

Do not measure or report plants which do not use water in the manufacturing process.

## Packaging Reuse Rate

### Definition

The number of times packaging accomplishes the same use, rotation or trip for which it was conceived and designed within its life cycle. Demonstration of reusability must first be established in accordance with EN 13429 or ISO/CD18603 once final.

### Metric

- Reusable – Yes or No according to EN 13429 or ISO/CD 18603
- Rate expressed as number of cycles and either the top-up or loss rate in steady-state operation of reuse scheme.

### Example

- Yes or No
- Reuse rate
- Number of cycles prior to withdrawal for recovery
- % loss per cycle of re-use
- % top up rate

### What to Measure

Determine if packaging conforms to definition of reusability per EN 13429 and ISO/CD 18603. If packaging is deemed reusable per referenced standards and guidelines, include all reused packaging components or packaging units. This metric can be used for primary, secondary and tertiary packaging. In cases where several packaging levels are being reused, their individual rates should be reported separately and not be cumulated.

### What Not to Measure

N/A

<sup>5</sup> <http://www.wbcds.org/templates/TemplateWBBCSD5/layout.asp?type=p&MenuId=MTUxNQ&doOpen=1&ClickMenu=LeftMenu=LeftMenu>

<sup>6</sup> [http://www.ifu.ethz.ch/staff/stpfiste/index\\_EN](http://www.ifu.ethz.ch/staff/stpfiste/index_EN)

## Packaging Recovery Rate

### Definition

The mass fraction or absolute mass of packaging recovered from all sources (commercial and residential) based on relevant waste management statistics.

#### 1. Demonstration of:

- Recoverability: EN 13427 + ISO/CD 18601
- Material Recycling: EN 13430 + ISO/CD 18604 + ISO/TR 16218 Chemical Recovery
- Energy Recovery: EN-13431 + ISO/CD 18605,
- Composting / Organic Recovery: EN 13432 + ISO/CD18606 <sup>7</sup>

2. **Recovery Rate:** expressed as % of total packaging weight [% wt.] put on the market or as mass expressed by rate × total packaging weight put on the market.

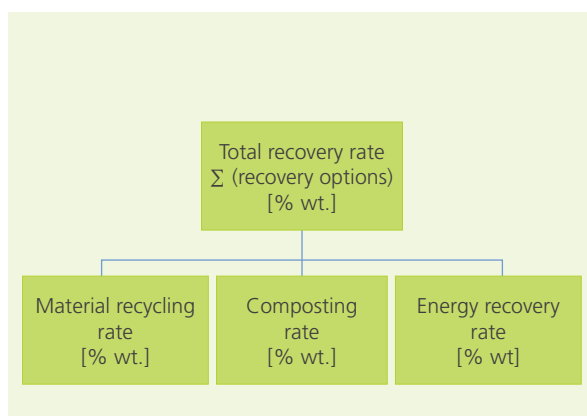

Figure 5. Total recovery rate expressed as the sum of material fractions recovered through material recycling, composting and energy recovery.

### Metric

- Recoverable – Yes, meeting criteria or No.
- Recovery rate [% wt.] with respect to total weight of packaging placed on the market per recovery option. Total recovery rate is the sum of individual recovery rates as indicated in Figure 5.

### Example

- Yes or No
- Recovery rate [% wt.]

### What to Measure

Determine if packaging conforms to the criteria for recoverability as per the relevant standards above. Include disclosure of material aspects of the package that would preclude recovery, for example, color, material combinations or coatings.

If criteria are fulfilled, express total recovery rate as % of total packaging weight put on the market that is effectively recovered and provide the break-down per practiced recovery option.

**Material Recycling:** measure each type of packaging produced and/or used for which national waste management recycling rates exist. Note that depending upon the packaging (type, shape, size, color) true recycling rates might not coincide with national recycling rates for specific material or packaging category.

**Composting:** measure each type of packaging produced and/or used for which national waste management industrial composting rates exist. Note that in many regions the rate of compost-

<sup>7</sup> Composting and biodegradation, ASTM D6400 – 04, ASTM D6868 - 03, ISO 14855-1 or other pertinent standards

ed organic waste may not coincide with the rate of composted packaging waste due to lack of acceptance.

**Energy Recovery:** If packaging is deemed to have energy recovery value and appropriate infrastructure exists, use national waste management statistics. If data is available, measure by material type.

**What Not to Measure**

Packaging going to final disposal and non-recovered littering is implicitly calculated from the recovery rate and does not need to be measured separately.

## Cube Utilization

**Definition**

Cube Utilization (CU) is the overall volumetric measurement of packaging design efficiency for the packaging system.

**Metric**

Percent of volume in a transport unit occupied by the product (%). In other words, total product volume in a transport unit divided by the volume of the transport unit.

**Example**

- % (ranging from 0% to 100%)

**What to Measure**

Product volume and transport unit volume must be measured correctly in order to calculate cube utilization (CU).

**Product Volume (PV):** The intent is to measure the volume of the product as shipped or for irregular objects to determine the smallest volume rectangular solid, cylinder, sphere or triangular solid in which a single item will fit and multiply this value by the number of items in the transport unit. A detailed protocol for determining PV can be found in Annex 1.

**Transport Unit Volume (TPV):** The transport unit is selected as the basis for the utilization calculation in order to properly measure the overall packaging design efficiency. Failure to do so could result in a reported value that overestimates cube utilization (e.g. a packaging system that is optimized on the primary, secondary, or tertiary level but not on all three).

**What Not to Measure**

The primary and secondary package dimensions do not need to be measured.

## References : Environmental – Attribute Indicators / Metrics

- A Practical Guide to using the CEN Standards – Essential Requirements for Packaging in Europe, EUROPEAN, 2005 (<http://www.europen.be/>).
- EN 13427:2004 Packaging – Requirements for the use of European Standards in the field of packaging and packaging waste.
- EN 13428:2004 Packaging – Requirements specific to manufacturing and composition – Prevention by source reduction.
- CEN/CR 13695-1:2004 Packaging – Requirements for measuring and verifying the four heavy metals and other dangerous substances present in packaging and their release into the environment - Part 1: Requirements for measuring and verifying the four heavy metals present in packaging.
- CEN/CR 13695-2:2004 Packaging – Requirements for measuring and verifying heavy metals and other dangerous substances present in packaging, and their release into the environment – Part 2: Requirements for measuring and verifying dangerous substances present in packaging and their release into the environment.
- EN 13429:2004 Packaging – Reuse.
- EN 13430:2004 Packaging – Requirements for packaging recoverable by material recycling.
- EN 13431:2004 Packaging – Requirements for packaging recoverable in the form of energy recovery, including specification of minimum inferior calorific value.
- EN 13432:2000 Packaging – Requirements for packaging recoverable through composting and biodegradation – Test scheme and evaluation criteria for the final acceptance of packaging.
- ISO 14021:1999 Environmental labels and declarations – Self-declared environmental claims (Type II environmental labeling).
- ISO 14855-1:2005 Determination of the ultimate aerobic biodegradability of plastic materials under controlled composting conditions — Method by analysis of evolved carbon dioxide — Part 1: General method. • ASTM D6400 – 04 Standard Specification for Compostable Plastics.
- ASTM D6868 – 03 Standard Specification for Biodegradable Plastics Used as Coatings on Paper and Other Compostable Substrates.
- ISO 14001:2004 Environmental management systems -- Requirements with guidance for use.
- The EU Eco-Management and Audit Scheme (EMAS) ([http://ec.europa.eu/environment/emas/index\\_en.htm](http://ec.europa.eu/environment/emas/index_en.htm)).

- Part 260- Guides for the Use of Environmental Marketing Claims Code of Federal Regulations, Title 16 – Commercial Practices, Chapter 1 – Federal Trade Commission, Subchapter B – Guides and Trade Practice Rules.
- ISO/CD 18601 Packaging – General requirements for the use of ISO standards in the field of packaging and the environment
- ISO/CD 18602 Packaging – Packaging and the environment: optimization of the packaging systems
- ISO/CD 18603 Packaging – Reuse
- ISO/CD 18604 Packaging – Packaging recoverable by material recycling
- ISO/CD 18605 Packaging – Packaging recoverable by energy recovery
- ISO/CD 18606 Packaging – Packaging recoverable by organic recovery
- ISO/TR 16218 Chemical recovery



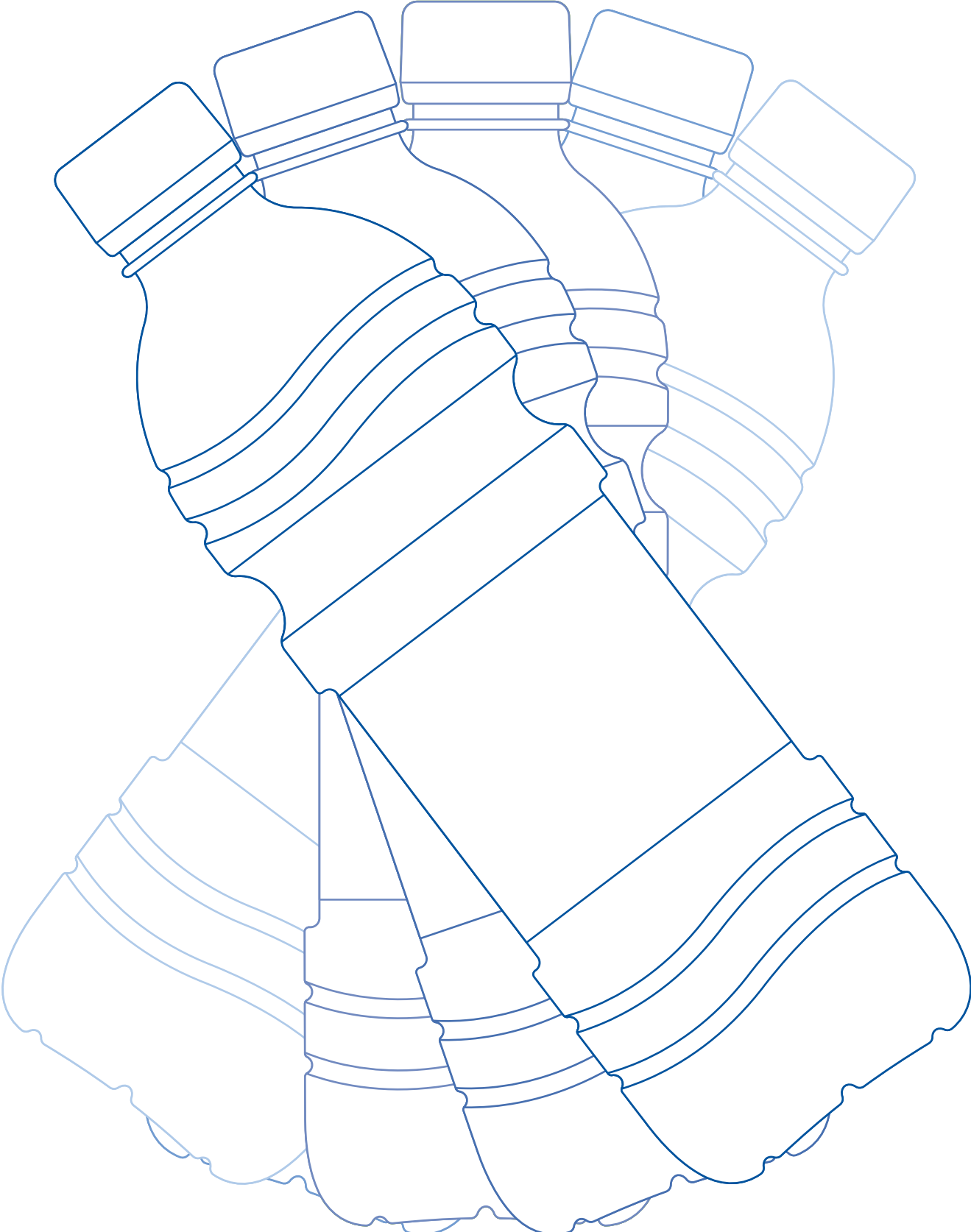

## Environmental – Life Cycle Indicators / Metrics

### Introduction to Life Cycle Assessment

Life Cycle Assessment (LCA) is a multi-criteria methodology to quantify the environmental impacts associated with the life cycle of a good or service, from the extraction of the product’s raw material to its final disposal after use. Concretely, all life cycle emissions, resource consumption and other environmental interventions are assessed for a set of relevant impact indicators, providing a full picture of the product’s environmental performance. The LCA

methodology and principles were standardized in recent years through the ISO 14040/44:2006 norm series, which ensures LCA studies of high quality and transparency.

According to ISO 14040, a LCA study shall include the following phases: definition of goal and scope, inventory analysis, impact assessment and interpretation of results, as illustrated in Figure 6, below.

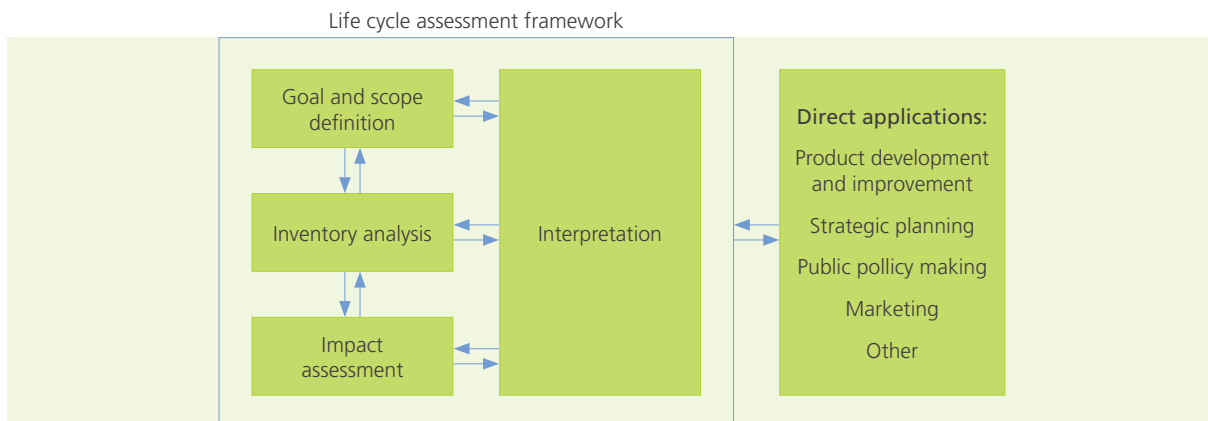

Figure 6. Stages and applications of LCA.

The specific criteria that have to be met concerning each individual phase are clearly described in the ISO 14040 and ISO 14044 standards. Further guidance can be found in the ILCD Handbook<sup>8</sup>. Packaging-specific life cycle assessment guidance can be found in CEN CR 13910:2000 and the future revision CEN CR 13910:2010.

The following issues require particular attention:

#### Goal and scope

General considerations – Before starting an LCA there are numerous aspects to consider and specifically the question of the decision to

be supported has to be in the center. From this, the following questions arise and have to be carefully considered before and during an assessment. Often this is an iterative process.

- relevance of a specific impact,
- relevance of a specific life cycle phase,
- relevance of specific elements in one life cycle phase,
- level of influence that the decision makers have over the elements and impacts in the life cycle,

<sup>8</sup> <http://ict.jrc.ec.europa.eu/pdf-directory/ILCD-Handbook-General-guide-for-LCA-DETAIL-online-12March2010.pdf>

- relevant differences between alternatives to be compared (vs. constant impacts),
- availability of data for the inventory analysis and impact assessment,
- uncertainties associated with the different inventory analysis and impact assessment data

**Functional Unit (FU)** – The functional unit is the quantified performance of a product system of packaging, for use as a reference unit in a LCA study. In the case of packaging products, it is important that the functional unit reflects the required packaging performance, which is linked to the packaged product. This might include: required strength of the packaging, required protection during transportation, preserving the quality of foodstuffs, protection against light penetration, prevention of residue production etc. Legal requirements in relation to the packaged product (e.g. foodstuffs), and the performance of the packaging in relation to machinery, might also be relevant to take into consideration. Depending on the point at which LCA information is exchanged in the supply chain the functional unit will change. For a material supplier providing plastic pellets to a converter a typical functional unit would be kg of pellets delivered to the customer. For a converter supplying packaging film to a customer the functional unit could be surface of a film with specified performance (m<sup>2</sup>) delivered to the customer, whereas for a brand owner or a retailer a functional unit could be number of servings in the case of a food product and in the

case of a detergent number of washing cycles or a weight of clothes washed or soil removed.

**System boundaries and cut-off rules** – The definition and application of system boundaries and of quantitative cut-off criteria by which certain processes or elementary flows are excluded from the considered system. Variations in cut-off criteria and system boundaries between different generic LCA databases used in one and the same study can have strong influence on the validity and accuracy of results. Attention is needed if the requirements for the system under study deviate significantly from the prevailing data.

#### Inventory analysis

**Allocation** – Various allocation rules exist for allocating inputs and outputs among products, byproducts, co-products as well as between systems providing and using recycled materials or recovered energy, for example. In particular for recycling and recycled content various material sectors have suggested allocation rules for particular material categories to adequately portray the given industries and the drivers for performance improvements (e.g. steel, aluminum, glass, PET bottle industry). There is currently no scientific consensus on a single allocation rule so it is of utmost importance to be clear and transparent on the allocation rules used.

#### Consistency between databases and datasets

If data are used from different sources the degree of consistency in methodology and the listed substances might influence the results

considerably. This holds true also for primary and secondary data. Primary data emanates directly from measurements done of the specific operations in questions, such as those of the reporting company, or of their own supply chain, whereas secondary data can be found in databases such as Ecoinvent, GaBi, Plastics Europe, IDEMAT. As the representativeness of such generic data might be limited in view of the system under study care is needed in interpretation.

**Data quality** - The data quality requirements should address the following aspects (ISO 14044, section 4.2.3.6.2):

1. time-related coverage: age of data and the minimum length of time over which data should be collected;
2. geographical coverage: geographical area from which data for unit processes should be collected to satisfy the goal of the study;
3. technology coverage: specific technology or technology mix;

The appropriateness of data needs interpretation to ensure that it corresponds to the data quality requirements determined for a particular study.

### Impact assessment

**Representative set of impact categories** – ISO 14040 & 14044 underline the importance of selecting a representative set of impact categories in order to avoid burden shifting. Single indicator approaches such as carbon-foot-print may hide adverse impacts caused in other impact categories.

**Data consistency with impact assessment methodology** – Impact assessment methods will be calculated based on the substances defined as inputs and outputs in inventories. If key substances contributing to a certain impact category are missing in the database used, then the assessment results will be incomplete and misleading. It is therefore important to understand the limitations of the data used to be able to interpret results in an appropriate manner.

**Global, regional and local impacts** – Impacts on the natural environment can be caused on different regional scales. Some impacts, such as climate change, occur on a global level, whereas other, such as acidification of lakes and forests occur on a regional level, and some such as water scarcity may be limited to one single locality.

For global impact categories a single set of characterization factors exist to aggregate the effects of a wide variety of substances into a single score.

The same approach is not possible for regional and local impacts as the sensitivity of the environment where the emissions occur may vary from one place to another. Impact assessment methods developed for regional impact categories, such as acidification and eutrophication, offer region-specific characterization factors for the regions where they have been developed, but rarely offer characterization factors for other regions. Despite this fact, it is recommended to use a single assessment method even for life cycles covering several regions, and

1. To use region-specific characterization factors when available, and
2. For regions where no characterization factors exist select existing ones as proxies based on similarities in ecosystems in terms of fate and exposure.

The use of proxies to characterize emissions where data on fate and exposure are missing is common practice in LCA for all regional environmental impacts.

For local impacts like water or land use – or at least impacts where local conditions considerably influence the severity of an intervention – the local conditions should be reflected in any further aggregation of data. In a variety of cases this is outside of the scope of a LCA and is not practical. Therefore it is justifiable to focus further analysis and interpretations only on flows which potentially contribute to damage. Geographic information systems and publicly available data allow access to such spatial information which can be used to reduce the number of flows which need to be interpreted to a manageable number.

### Interpretation

**Describe assumptions and hypotheses** – Assumptions and hypotheses made in absence of tangible data may have a significant effect on conclusions drawn. Therefore it is important to clearly and transparently communicate assumptions and hypotheses made in order to allow the receiving party to evaluate their applicability in a given context.

**Sensitivity check** – Check the robustness of conclusions to variations in assumptions and hypotheses made by selecting high and low estimates and by varying the cut-off criterion used for the system definition. If the conclusions of the study remain the same the conclusions can be considered robust.

**Uncertainty assessment** – There is a wide variety of sources of uncertainty in life cycle assessment, ranging from data age and representativeness of normal running conditions of a particular process to uncertainties in impact assessment methods. The propagation of such uncertainty through the model should always be considered. Recognition of this uncertainty underlines the importance of sensitivity checks to evaluate the robustness of conclusions drawn.

### Product comparisons

LCA can be used for the analysis of hot spots in a product system and allows the detection of improvement options. It also allows deriving a comparative assertion which can be disclosed to the public provided that the results are peer reviewed by an external review panel according to the requirements of ISO 14040/44: 2006. A comparative assertion is the claim for environmental superiority of one product over the other. In such context, many more requirements and provisions ensure a fair and balanced comparison. In particular, if impact scores are shared as environmental metrics along the supply chain, interpretation is necessary to draw adequate conclusions from the difference between two indicator scores for one and the same impact category.

Global Warming Potential (GWP)

1. Definition

Global warming potential is a measure of a process' contribution to climate change. The ability of chemicals to retain heat on the earth (radioactive forcing) is combined with the expected lifetime of these chemicals in the atmosphere and expressed in CO<sub>2</sub> equivalents.

2. Metric

Mass of CO<sub>2</sub> equivalents, e.g. [kg CO<sub>2</sub> eq / FU], using the characterization factors of the 4th assessment report of the Intergovernmental Panel on Climate Change (IPCC). A 100 year time perspective is recommended. The time perspective chosen should always be communicated together with the metric.

3. Who/What at the end am I damaging?

Global warming will result in a net global increase of temperatures, which will be translated into very different and hardly predictable changes in climate on a local scale. These include increased or decreased precipitation, more extreme climatic events (storms, draughts), and even possibly global changes in ocean currents (Gulf Stream). This has dramatic effects on nature (modifying entire ecosystems), humans (more natural disasters, more heat-related disease, such as heart attacks, wider spread of diseases currently limited to tropical regions, such as malaria), and the economy (more natural disasters, better or worse agricultural yields, depending on the local climate).

4. How do I damage?

Emissions of greenhouse gases change the radiation equilibrium of the earth, retaining a larger amount of infrared radiation that previously was released into space. The most important greenhouse gases are water vapor and carbon dioxide (CO<sub>2</sub>), which is released from combustion processes<sup>9</sup>. Other potent greenhouse gases are methane (CH<sub>4</sub>, from livestock farming, rice cultivation, and landfills), and nitrous oxide (N<sub>2</sub>O, mainly from fertilizer application in agriculture).

5. Why does it matter?

Climate change is a serious environmental threat, with potentially dramatic impacts. A reduction of greenhouse gases is very urgent, since non-reversible change to the global climate may occur if the current amount of greenhouse gases will be emitted for only a few more years.

6. What do I have to check, take into account in my supply chain?

Impacts on global warming occur in particular if energy from fossil fuels is consumed, or agricultural activities with fertilizer use are within the system boundaries. If biogenic resources are employed, significant uptake of CO<sub>2</sub> may occur, which in LCA is accounted for as a negative emission of greenhouse gas.

<sup>9</sup> Contribution of Working Group I to the Fourth Assessment Report of the Intergovernmental Panel on Climate Change, 2007. Cambridge, United Kingdom and New York, NY, USA.: Cambridge University Press, 2007.

**7. When do I have to use/select/consider this indicator?**

Global warming potential is influenced by the use of fossil resources and can be a valuable indicator to detect differences in intensity of fossil resource use or when comparing systems based on fossil resources with systems based on renewable resources.

**8. How specific can I interpret the resulting indicator?**

Know-how on climate change has increased drastically in the past, and the global warming potential is a relatively reliable indicator today. Soil emissions of greenhouse gases from agriculture (changes of carbon content in soil due to cultivation practices or emissions of N<sub>2</sub>O after fertilizer application) are strongly dependent on local soil conditions, and therefore, have high uncertainties in inventory databases. Although the 100 year perspective is considered in most policy initiatives today, some consider the 500 year perspective to be more scientifically robust. Examining the 500 year perspective as a sensitivity check might therefore prove useful.

**9. How can I reduce uncertainty & evaluate the significance of an impact?**

Make sure agricultural processes are correctly parameterized in your inventory database.

**10. Who to ask, where to look?**

Global warming potentials of greenhouse gases are given in the fourth IPCC assessment report (2007) and readily available in many impact assessment methods. Further guidance on carbon footprinting is provided by the World Resources Institute / World Business Council for Sustainable Development Green House Gas Protocol <http://www.ghgprotocol.org/>, PAS 2050 (BSI), and ISO14067 (when available).

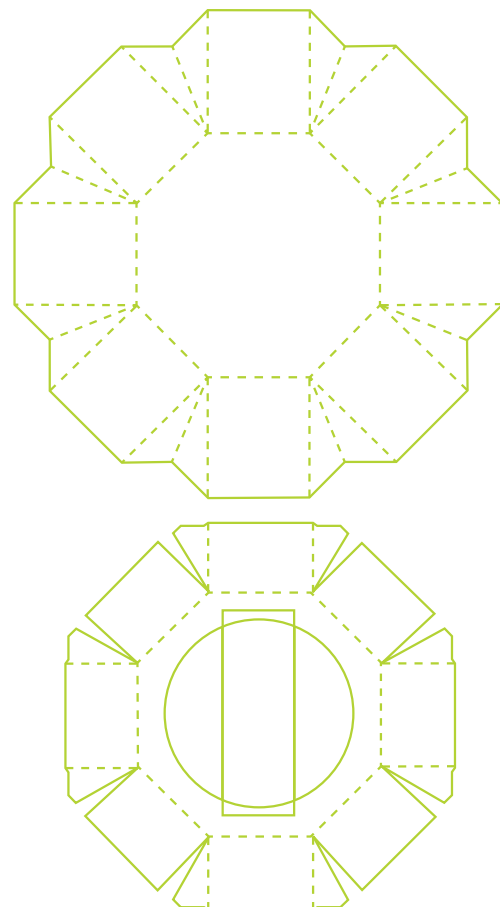

## Ozone Depletion

### 1. Definition

This indicator measures the degradation of the earth's stratospheric ozone layer caused by certain types of pollutants, such as chlorofluorocarbons. The earth's stratospheric ozone layer is important in blocking ultraviolet light and when degraded, allows too much ultraviolet light to reach the earth's surface, potentially damaging human and ecological health.

### 2. Metric

Mass of CFC-11 equivalents [kg CFC-11 eq. / FU] using the WMO 1990 factors which are implemented in a wide range of impact assessment methodologies.

### 3. Who/What at the end am I damaging?

Excessive ultraviolet light is damaging to human health, as well as to ecosystems. Human health effects include increased incidence of skin cancer and cataracts. Ecological effects include damage to plants (which impairs the primary productivity of ecosystems), and loss of plankton populations (impairing the oceans' productivity).

### 4. How does it damage?

Emission of ozone depleting substances lead to loss of stratospheric ozone, allowing more ultraviolet light to reach the earth's surface.

### 5. Why does it matter?

Due to bans on the most serious ozone depleting substances following the 1987 Montreal Protocol, the depletion of stratospheric ozone is a lesser concern today than several decades ago, even though the hole in the ozone layer remains.

### 6. What do I have to check, take into account in my supply chain?

Ozone depleting substances are most often used in refrigeration and foaming systems. Although aerosol spray cans once contained ozone depleting substances as propellants, a ban on those substances has made this a non-issue. Most of these materials are regulated under the Montreal Protocol, so it should be relatively easy to determine if they are still being used in the supply chain.

### 7. When do I have to use/select/consider this indicator?

It should be considered a low-priority issue that can be reported for completeness, but is now rarely a major focus of environmental disclosures.

### 8. How specific can I interpret the resulting indicator?

Ozone depletion results, provided the inventory is of good quality, can be viewed as highly reliable. The prominent chemicals causing damage to stratospheric ozone have been well documented and their relative potency is well measured.



**9. How can I reduce uncertainty & evaluate the significance of an impact?**

Ozone Depletion results should be interpreted as reflecting potential impacts, rather than real ones. If inventory data is of high quality, uncertainty should be relatively low and in the absence of a formal uncertainty assessment, many would view a difference of ~20% as a significant improvement. A lesser margin may be needed if the two systems being compared are substantially similar (same packaging materials, products, etc.)

**10. Who to ask, where to look?**

WMO 1990 factors, as implemented in ReCiPe, IMPACT 2002+, TRACI, LIME2, and other impact assessment methodologies.

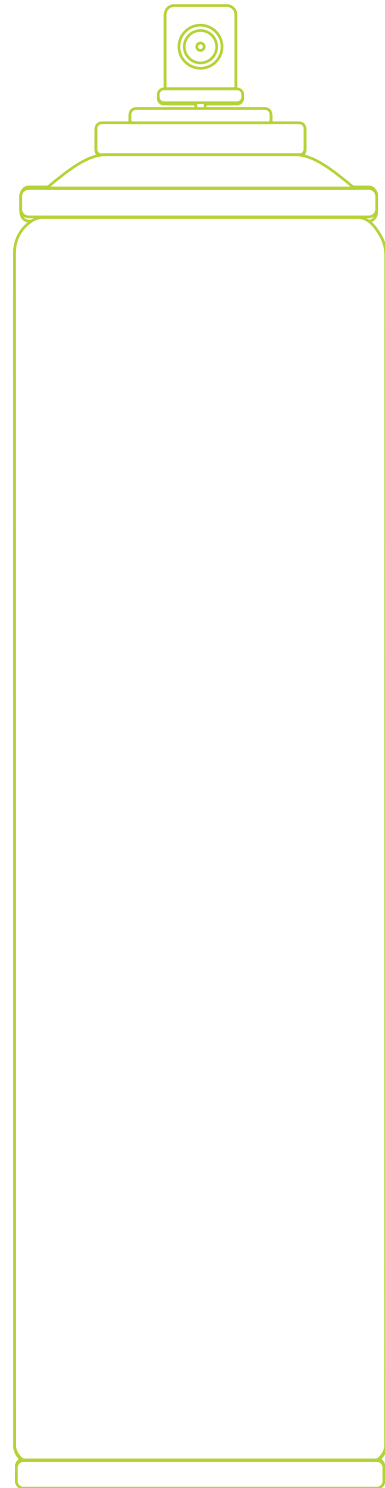

## Impact on Human Health

### Toxicity, Cancer

#### 1. Definition

Numerous pollutants released to the environment are known to cause cancer. The Toxicity, Cancer indicator evaluates to potential cancer-related health outcomes that may occur due to the emissions associated with a given product or process.

#### 2. Metric

Measured based on the potential of a chemical release to cause cancer relative to the emissions of a reference substance, such as vinyl chloride or benzene to air, e.g. [kg C<sub>2</sub>H<sub>3</sub>Cl eq / FU or kg C<sub>6</sub>H<sub>6</sub> air eq / FU]. The reference substance used may vary depending on the impact assessment method applied. The USEtox system measures this category in critical toxic units (CTU).

#### 3. Who/What at the end am I damaging?

Cancer is among the leading causes of human mortality in the developed world.

#### 4. How does it damage?

Emissions of cancer causing substances can occur in a wide range of industrial processes, from factory emissions to vehicle exhaust. Of these pollutant emissions, some will result in exposure to humans and influence the chances of adverse cancer outcomes.

#### 5. Why does it matter?

Cancer is among the leading causes of human mortality in the developed world.

#### 6. What do I have to check, take into account in my supply chain?

Most industrial processes will have some emissions to include in this category and therefore a complete accounting of the product life cycle is important.

#### 7. When do I have to use/select/consider this indicator?

Changes in materials may often influence toxic emissions and so it is a useful metric to consider whenever various type of materials are being compared. For example, metals may have a very different profile of toxic emissions than plastics.

#### 8. How specific can I interpret the resulting indicator?

Current methods provide the best available science regarding the transport of toxic chemicals in the environment, their routes of exposure to humans, and the resulting cancer outcomes. Nevertheless, because of the complexity involved, toxicity indicators are often viewed as among the most uncertain in life cycle impact assessment, with a substantial margin in one direction desired to support a determination of an advantage or disadvantage.

#### 9. How can I reduce uncertainty & evaluate the significance of an impact?

Toxicity, Cancer results should be interpreted as reflecting potential impacts, rather than real ones. Uncertainty can be reduced by ensuring that high quality life cycle inventory data is used and that the most current assessment methods (e.g., USEtox) are employed.

#### 10. Who to ask, where to look?

On the USEtox homepage ([www.usetox.org](http://www.usetox.org)), and in the documentation of other impact assessment methods.

### Toxicity, Non-Cancer

#### 1. Definition

Numerous pollutants released to the environment are known to cause harmful toxic effects on human health. The Toxicity, Non-cancer indicator evaluates to potential adverse non-cancer health outcomes that may occur due to the toxic emissions associated with a given product or process.

#### 2. Metric

Measured based on the potential to cause non-cancer toxic health outcomes relative to a reference, e.g. toluene, expressed as mass equivalents, e.g. [kg toluene eq / FU]. The reference substance used may vary depending on the impact assessment method applied. The USEtox system measures this category in critical toxic units (CTU).

#### 3. Who/What at the end am I damaging?

A wide variety of human health impacts can be linked to the emission of toxic substances to the environment.

#### 4. How does it damage?

Emissions of toxic substances can occur in a wide range of industrial processes, from factory emissions to vehicle exhaust. Of these pollutant emissions, some will result in exposure to humans and influence the chances of adverse health outcomes.

#### 5. Why does it matter?

Non-cancer related health impacts from toxic environmental pollution are an important cause of human morbidity and mortality.

#### 6. What do I have to check, take into account in my supply chain?

Most industrial processes will have some emissions to include in this category and therefore a complete accounting of the product life cycle is important.

#### 7. When do I have to use/select/consider this indicator?

Changes in materials may often influence toxic emissions and so it is a useful metric to consider whenever various type of materials are being compared. For example, metals may have a very different profile of toxic emissions than plastics.

#### 8. How specific can I interpret the resulting indicator?

Current methods provide the best available science regarding the transport of toxic chemicals in the environment, their routes of exposure to humans, and the resulting cancer outcomes. Nevertheless, because of the complexity involved, toxicity indicators are often viewed as among the most uncertain in life cycle impact assessment, with a substantial margin in one direction desired to support a determination of an advantage or disadvantage.

**9. How can I reduce uncertainty & evaluate the significance of an impact?**

Toxicity, Non-Cancer results should be interpreted as reflecting potential impacts, rather than real ones. Uncertainty can be reduced by ensuring that high quality life cycle inventory data is used and that the most current assessment methods (e.g., USEtox) are employed.

**10. Who to ask, where to look?**

On the USEtox homepage ([www.usetox.org](http://www.usetox.org)), and in the documentation of other relevant impact assessment methods.

## Particulate Respiratory Effects

### 1. Definition

Particulate matter represents a complex mixture of organic and inorganic substances of varying dimensions capable to suspend in air. Given the complexity and variety in terms of chemical composition of particulate matter, their characterization and quantification in air is typically performed on the basis of physical measures such as PM<sub>10</sub> (covering particles with a diameter smaller than 10 µm) and PM<sub>2.5</sub> (covering particles with a diameter smaller than 2.5 µm).

### 2. Metric

Mass of PM<sub>10</sub> equivalents [kg PM<sub>10</sub> eq / FU] as described in the ReCiPe impact assessment methodology (midpoint level) is recommended for this indicator due to high acceptance from stakeholders and the availability in software systems and data bases. It is expected that this method will be subject to further development.

### 3. Who/What at the end am I damaging?

Because of their small size, particulate matter can infiltrate into the airways, causing morbidity and respiration distress. The ability of particulate matter to penetrate the respiratory system is a function of their size, whereby PM<sub>10</sub>, also known as the thoracic fraction, reach the upper airways and lungs, whereas PM<sub>2.5</sub>, also known as the respirable fraction, can penetrate the deepest part of the lungs.

### 4. How does it damage?

Particulate matter has both primary and secondary emission sources. Fuel combustion (of both fossil and biogenic origin) represents a key primary source of particulate matter in form of fly ash and soot (if exhaust gas is not appropriately treated). Particulate matter can also be formed through secondary pathway from emissions of sulfur dioxide (SO<sub>2</sub>), ammonia (NH<sub>3</sub>), and nitrogen oxides (NOx) among others.

### 5. Why does it matter?

Particulate matter has a severe effect on human health, especially if exposure to it is chronic. The effects of inhaling particulate matter include asthma, lung cancer, cardiovascular issues, and premature death. Exposure to particulate matter is particularly significant in densely populated metropolitan areas. Limits for PM<sub>10</sub> are in force in many industrialized countries. Recently, regulatory emphasis was also laid on PM<sub>2.5</sub>.

### 6. What do I have to check, take into account in my supply chain?

The main processes contributing to particulate matter formation are stationary and mobile

combustion processes such as power generation in coal- or oil-fired power plants or combustion engines from transport vehicles. The energy supply and generation chain as well as transport processes are of key relevance. Otherwise no significant direct emission of particulate matter (or its precursor) can be associated with the packaging industry.

**7. When do I have to use/select/consider this indicator?**

The use of particulate matter formation potential indicator is particularly recommended as complementary indicator in contexts where energy use or processes related to transport have a significant share in the environmental profile of a packaging product.

**8. How specific can I interpret the resulting indicator?**

The particulate matter concentration in air is only an indicative measure of associated human health burden – the size distribution is a similarly significant factor, but the existing data basis and assessment methodologies are not adequate to take this aspect into account. Moreover, the actual exposure by humans to particulate matter is a function of the meteorological conditions. Precipitation can act as significant removal process of fine particulate matter.

**9. How can I reduce uncertainty & evaluate the significance of an impact?**

Results should be interpreted as reflecting potential impacts, rather than real ones. Separate accounting for  $PM_{10}$  and  $PM_{2.5}$  would increase

the significance of the results, as more severe health effects are attributable to the latter.

**10. Who to ask, where to look?**

There is not yet full consensus on the most appropriate methods, but several recognized methods are available (see <http://ict.jrc.ec.europa.eu/pdf-directory/ILCD-public-consultation-third-part.pdf>). Further information for this indicator can be found on the ReCiPe homepage ([www.lcia-recipe.net](http://www.lcia-recipe.net)) and in the documentation of other impact assessment methods.

## Ionizing Radiation

### 1. Definition

The ionizing radiation indicator reflects the potential burden to human health related to the exposure to radionuclides. Not considered are exposure due to large and severe accidental releases and occupational exposure to radioactive substances.

### 2. Metric

Mass of kg U235 equivalent, e.g. [kg U235 eq / FU] using the “Ionizing radiation” indicator at a midpoint level with the hierarchist perspective, according to the approach described in Frischknecht et al, 2000 which is used in the ReCiPe, IMPACT 2002+ , Ecoindicator 99, and Swiss Ecofactor methodologies.

### 3. Who/What at the end am I damaging?

A routine exposure to radionuclides can result in carcinogenic and hereditary effects with detrimental consequences on the human health.

#### 4. How does it damage?

Release of radionuclides into the environment (air or water) can result from the nuclear fuel cycle (mining and milling, conversion, enrichment, fuel fabrication, electricity production, and re-processing), in phosphate rock extraction, in coal power plants and in oil and gas extraction. Important radionuclides are Carbon-14 (C-14), Tritium (H-3), Iodine-129 (I-129) and Krypton-85 (Kr-85). All four radionuclides have long life time and can potentially be distributed globally. Human exposure can result through inhalation or consumption of contaminated food and water.

#### 5. Why does it matter?

Ionizing radiation has significant negative consequences on the human health, leading to fatal and non-fatal cancer-related and hereditary effects.

#### 6. What do I have to check, take into account in my supply chain?

The energy supply and generation chain is of key relevance with regard to the ionizing radiation indicator. Virtually all products contribute to the ionizing radiation burden through the energy chain.

#### 7. When do I have to use/select/consider this indicator?

The use of the ionizing radiation indicator is particularly recommended as additional indicator in contexts where energy use has a significant share in the indicator profile of a packaging product.

#### 8. How specific can I interpret the resulting indicator?

The dispersion and exposure pathways of radionuclides are affected by considerable uncertainties. This holds particularly true for the modeling of the global transport of radionuclides because of the simplified models used to model the propagation of very small doses over a large population for very long period of time. Note that the impact of ionizing radiation on ecosystem quality is not considered so far, although identified as issue.

#### 9. How can I reduce uncertainty & evaluate the significance of an impact?

Great care and caution should be exercised in making comparisons of systems based on this indicator as differences in data completeness and quality in underlying data can make such comparisons problematic or even invalid. Ionizing radiation results should be interpreted as reflecting potential impacts, rather than real one.

#### 10. Who to ask, where to look?

Further information can be found on the ReCiPe homepage, [www.lcia-recipe.net](http://www.lcia-recipe.net).

## Photochemical Ozone Creation Potential (POCP)

### 1. Definition

Photochemical Ozone Creation Potential (POCP) is the potential of ozone creation at ground level (i.e. tropospheric ozone) through photochemical transformation of ozone precursor emissions. The main ozone precursor compounds are nitrogen oxides (NO<sub>x</sub>) and non-methane volatile organic compounds (NMVOC).

### 2. Metric

Mass of non-methane volatile organic compound equivalents, e.g. [kg NMVOC eq / FU] calculated using the “photochemical oxidant formation potential” indicator at a midpoint level, as described in the ReCiPe impact assessment methodology.

### 3. Who/What at the end am I damaging?

Ground-level ozone (a constituent of smog) represents a health hazard to human health because it can irritate the respiratory system and reduce lung function. High ozone concentrations lead to an increased frequency and severity of respiratory distress, such as asthma. Further, ozone can increase susceptibility to respiratory infections.

### 4. How does it damage?

Ozone is not directly emitted into the atmosphere, but it is formed as a result of photochemical reactions of NO<sub>x</sub> and NMVOCs. Ozone precursor emissions are typically released from man-made sources, namely petrol, paints and solvents (for NMVOC) or generated through combustion processes (for NO<sub>x</sub>). In addition emissions may occur from natural sources (pines and fruit trees).

### 5. Why does it matter?

Ground-level ozone represents an acute health hazard for humans. The exposure to ground-level ozone is particularly important in urban areas, but can also be relevant in rural areas because of air circulation processes. The photochemical formation process is particularly intense in summer because of more intense sun irradiation and higher temperatures.

### 6. What do I have to check, take into account in my supply chain?

In general, stationary and mobile combustion processes such as power generation in coal- or oil-fired power plants and road transportation are key sources of ozone precursor emissions. Specifically for the packaging industry, solvent-based processes like printing and coating represent a potential source of NMVOCs (if exhaust gases are not appropriately treated).

### 7. When do I have to use/select/consider this indicator?

The use of the ozone formation indicator is particularly recommended for energy-intensive packaging products as well as for packaging production activities involving solvent-based processes. They are expected to score higher on this indicator.

**8. How specific can I interpret the resulting indicator?**

The ozone formation does not depend on the presence of NO<sub>x</sub> and/or NMVOC compounds only, but appropriate weather conditions - high temperatures and intense sun irradiation – must be given as well to start and fuel the process of forming this smog. The impact of photochemical oxidant formation on ecosystem quality is not considered so far, although identified as issue.

**9. How can I reduce uncertainty & evaluate the significance of an impact?**

POCP results should be interpreted as reflecting potential impacts, rather than real one.

**10. Who to ask, where to look?**

Further information can be found on the ReCiPe homepage ([www.lcia-recipe.net](http://www.lcia-recipe.net)), LIME2 (<http://lca-forum.org/database/impact/>) and in the documentation of other impact assessment methods.

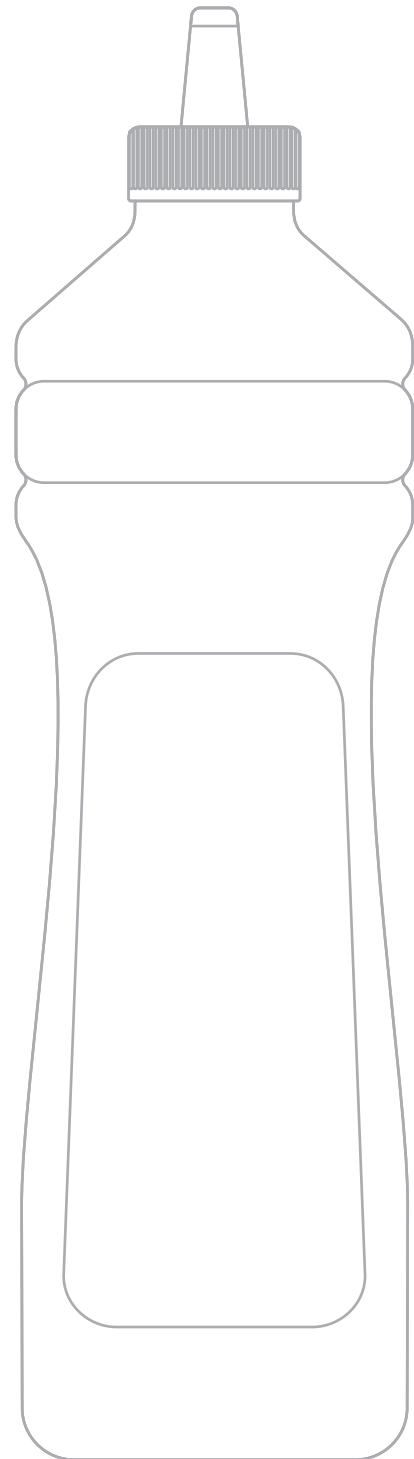



## Impact on Ecosphere

### Acidification Potential

#### 1. Definition

Acidification Potential is the potential of a chemical emission to acidify ecosystems. Emissions of acidifying substances strongly depend on industrial practice and environmental legislation.

#### 2. Metric

The “Terrestrial Acidification” indicator, calculated at a mid-point level based on the potential impact relative to emissions of the reference substance  $\text{SO}_2$  as mass of  $\text{SO}_2$  equivalents is recommended, e.g. [ $\text{kg SO}_2 \text{ eq} / \text{FU}$ ].

In the absence of a single methodology possessing region-specific global characterization factors, regional models are recommended according to prevailing practice: TRACI (North America), ReCiPe in hierarchical perspective (Europe), LIME2 (Japan). In case of doubt, ReCiPe using the hierarchical perspective is recommended as a default method. For studies spanning several regions, the use of a single method across regions is recommended according to the procedure described in the introduction.

#### 3. Who/What at the end am I damaging?

The natural environment in soil, freshwater systems, and oceans are modified if their pH is reduced (they become more acidic). In acidic soils, the availability of many nutrients is reduced, resulting in decreased agricultural yields and forests dying. In acidified lakes, many fish species can no longer survive. The severity of the impact depends on the buffer capacity of the receiving media (water or soil).

#### 4. How does it damage?

Emissions of acidifying substances into atmosphere are the main contributors to soil and freshwater acidification. The most important acidifying substances are sulfur dioxide ( $\text{SO}_2$ ), nitrogen oxides ( $\text{NO}_x$ ), and ammonia ( $\text{NH}_3$ ), which can be transported over long distances in the atmosphere, before they react to form sulfuric acid ( $\text{H}_2\text{SO}_4$ ) and nitric acid ( $\text{HNO}_3$ ). In the form of acid rain these substances precipitate and acidify soils, freshwater systems, and oceans.

Coal- and oil-fired power plants and metallurgical activities produce large amounts of sulfuric dioxide, if no exhaust gas treatment systems are used. Nitrogen oxides are produced by combustion processes in transport and industry, and ammonia is produced by agricultural activities, in particular livestock growing.

#### 5. Why does it matter?

Acid rain has severe impacts on forests, agricultural lands, and freshwater systems. In recent years, stricter regulation in Europe and the United States has reduced the overall emission loads of acidifying substances. In other countries (in particular in countries with weak legislation on air emissions) this is still a major problem.

#### 6. What do I have to check, take into account in my supply chain?

Processes that can strongly contribute to acidification are power generation in coal- or oil-fired power plants without flue gas desulfurization, metallurgical processes, and livestock growing.

**7. When do I have to use/select/consider this indicator?**

When materials from different countries are used, and one country has different local industrial practices or environmental legislation, it is recommended to assess acidification potential.

**8. How specific can I interpret the resulting indicator?**

The inventory data on acidifying substances is rather well established, since it depends mainly on well-studied processes (energy generation and metallization). Therefore, inventory data can be interpreted quite specifically.

The characterization factors for the acidification potential of the contributing substances have been extensively investigated.

The impact depends strongly on the fate (in terms of acid rain formation) and exposure (in terms of the sensitivity of the receiving environment): some soils may be extremely fragile to acidification (soils on granite rocks), others may exhibit a large buffer potential (soils on carbonate rocks). Since characterization factors for acidification are generally global averages, the impact assessment results may not be representative of the actual situation on a regional or local scale. Regional models such as TRACI (North America), ReCiPe and EDIP2003, Accumulated Exceedance (Europe) and LIME2 (Japan) have been introduced to increase the relevance and significance for this indicator. Each method models fate and exposure in different ways and proposes different characterization factors.

**9. How can I reduce uncertainty & evaluate the significance of an impact?**

If knowledge is available on the sensitivity of the receiving environment, regional characterization factors might be applied. If the methodology used does not provide characterization factors for all regions considered in a study, it is recommended to select existing ones as proxies for these regions based on the principles laid out for regional impact categories in the introduction.

**10. Who to ask, where to look?**

Further information on methodologies readily available in LCA software:

- ReCiPe ([www.lcia-recipe.net](http://www.lcia-recipe.net))
- EDIP2003 (Hauschild & Potting 2004)
- LIME2 (<http://lca-forum.org/database/impact/>)
- TRACI (<http://www.epa.gov/nrmrl/std/sab/traci/>)

Further information on the concept of Accumulated Exceedance (AE) which has very high scientific relevance, but is not yet readily available in impact assessment methodologies can be found in the works of Seppälä et al. 2006 and Posch et al. 2008.

## Aquatic Eutrophication

### 1. Definition

Aquatic Eutrophication occurs when excessive amounts of nutrients reach freshwater systems or oceans. Algae bloom may result and fish may disappear. Whereas phosphorous is mainly responsible for eutrophication in freshwater systems, nitrogen is mainly responsible for eutrophication in ocean water bodies.

### 2. Metric

The Aquatic Eutrophication indicator based on the potential impact relative to the reference substance phosphorous, i.e. [kg P eq / FU] is recommended for freshwater eutrophication and mass of nitrogen equivalents [kg N eq] / FU] is recommended for marine eutrophication. In the absence of a single methodology possessing region-specific global characterization factors, regional models are recommended at midpoint level according to prevailing local practice: ReCiPe freshwater and marine eutrophication indicators using a hierarchical perspective or EDIP2003 (Europe), LIME2 (Japan), or TRACI (North America).

### 3. Who/What at the end am I damaging?

When freshwater systems and oceans receive an excessive amount of nutrients, algae grow excessively. When these algae die, their degradation will consume oxygen in the water depriving animal species of oxygen with effects such as decreased biodiversity, changes in species composition and dominance as well as toxicity effects resulting from algae blooming. Complete oxygen depletion results in "dead zones" where animal species are completely extinguished.

### 4. How does it damage?

Phosphorous and nitrogen are both required for an ecosystem to become eutrophic. In countries with poor water protection regulation, many detergents still contain phosphorous and contribute heavily to eutrophication. Agriculture, in particular fertilizer use, is a major source of phosphorous emission. Nitrogen can come from different sources, in particular urban waste water treatment facilities, fertilizer use in agriculture, manure from livestock growing installations, and emissions of nitrogen compounds into the atmosphere.

### 5. Why does it matter?

Besides that eutrophication will result in population losses among animal species, eutrophication also has severe economic consequences: Eutrophic oceans and lakes lose their production potential for fishing. Furthermore, tourism is negatively affected if algae bloom occurs.

It takes many years to bring back eutrophic water bodies into their natural state. In lakes, it has been attempted to accelerate this process by artificially injecting oxygen into the water bodies. However, this has turned out to be a very cost-intensive process.

**6. What do I have to check, take into account in my supply chain?**

Processes that can strongly contribute to eutrophication are detergent use in a country with poor water protection legislation and agricultural activities, in particular fertilizer use and livestock growing.

**7. When do I have to use/select/consider this indicator?**

When using fuels and materials sourced from biomass, in particular agriculture, eutrophication should be taken into account.

**8. How specific can I interpret the resulting indicator?**

Since both, phosphorous and nitrogen are required for eutrophication to occur, it is possible that emissions of nitrogen into a phosphorous-poor lake will not result in eutrophication. In another lake that is abundant in phosphorous, however, emissions of the same amount of nitrogen might result in eutrophication.

In general, lakes are poor in phosphorous, whereas ocean bodies are poor in nitrogen.

**9. How can I reduce uncertainty & evaluate the significance of an impact?**

By using separate indicators for freshwater and marine eutrophication, the significance of the indicator can be considerably improved (as suggested here).

**10. Who to ask, where to look?**

The homepage for the ReCiPe impact assessment method ([www.lcia-recipe.net](http://www.lcia-recipe.net)) provides further information on aquatic eutrophication. Descriptions of the EDIP2003, LIME2, or TRACI assessment methods also provide guidance.

Further information on the concept of Accumulated Exceedance (AE) which has very high scientific relevance, but is not yet readily available in impact assessment methodologies can be found in the works of Seppälä et al. 2006 and Posch et al. 2008.

## Freshwater Ecotoxicity Potential

### 1. Definition

This indicator measures the release of chemicals that have adverse effects on freshwater aquatic wildlife.

### 2. Metric

Measured based on the ecotoxicity potential relative to a unit of mass of a reference substance, e.g. CTU<sub>e</sub> (comparative toxic units for ecotoxicity potential) for USEtox, 1,4-Dichlorobenzene [kg 1,4 DB equivalent/FU] used in CML 2001 and ReCiPe (Europe), 2,4-Dichlorophenoxyacetic acid [kg 2,4 D equivalents/FU] as in TRACI (North America).

### 3. Who/What at the end am I damaging?

When freshwater ecosystems receive excessive amounts of toxic pollution, it can cause death or reproductive disabilities in wildlife, eventually leading to loss of species, biodiversity and ecosystem productivity.

#### 4. How does it damage?

Toxic substances may affect aquatic wildlife in a variety of ways, ranging from subtle health effects that influence abilities to survive and reproduce, to directly causing the death of wildlife.

#### 5. Why does it matter?

Freshwater ecosystems that are damaged are less productive, providing less service to humans, such as in the form of fishery productivity. In addition, damage to wildlife may lead to the irreversible loss of species.

#### 6. What do I have to check, take into account in my supply chain?

Most industrial processes will have some emissions to include in this category and therefore a complete accounting of the product life cycle is important.

#### 7. When do I have to use/select/consider this indicator?

Changes in materials may often influence toxic emissions and so it is a useful metric to consider whenever various type of materials are being compared. For example, metals may have a very different profile of toxic emissions than plastics.

#### 8. How specific can I interpret the resulting indicator?

Current methods provide the best available science regarding the transport of toxic chemicals in the environment and their damage to ecosystems. Nevertheless, because of the complexity involved, toxicity indicators are often viewed as among the most uncertain in life cycle impact assessment, with a substantial margin in one

direction desired to support a determination of an advantage or disadvantage.

#### 9. How can I reduce uncertainty & evaluate the significance of an impact?

Cancer Toxicity results should be interpreted as reflecting potential impacts, rather than real ones. Uncertainty can be reduced by ensuring that high quality life cycle inventory data is used and that the most current assessment methods (e.g., USEtox) are employed.

#### 10. Who to ask, where to look?

On the USEtox homepage (<http://www.usetox.org>) and in the documentation of other relevant impact assessment methods.

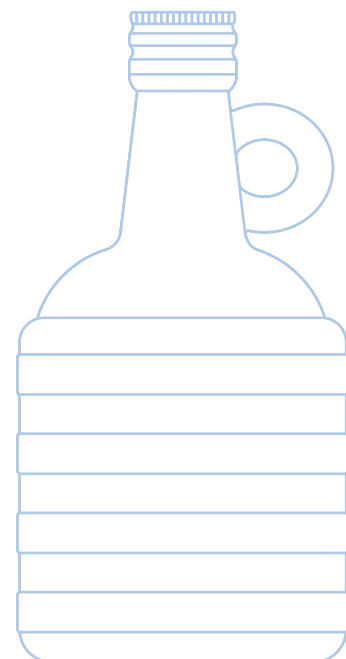

## Impact on Resource Base

### Non-Renewable Resource Depletion

#### 1. Definition

A measure of the depletion of non-renewable resources per functional unit in the packaging supply chain.

#### 2. Metric

Measured relative to a reference substance e.g.

a) kg antimony equivalents / FU [CML 2002] or;

b) Person reserve (kg) / FU [EDIP 1997 (updated 2004)].

#### 3. Who/What at the end am I damaging?

Depletion of non-renewable resources, such as metals, minerals and fossil fuels, decreases the availability of such resources for future use. This can in turn necessitate either a forgoing of future benefits of use or the incurring of other impacts by providing the same or similar function through alternate means. If resources are turned from deposits to commodities, the resources in their given concentration in the earth's crust are lost for future uses. Therefore, additional efforts will be required in future to convert less concentrated deposits to use. These additional future efforts will cause an additional harm to the natural environment.

The safeguard object is natural resources.

#### 4. How does it damage?

By denying resources, or resources in given concentration, to future users. Further, by obliging future users to substitute lower availability resources one potentially incurs additional environmental interventions in the form of emissions to land, water and air.

The extraction of mineral resources and fossil fuels is associated with a variety of environmental impacts in particular during mining operations. However, these impacts are more appropriately covered by other life cycle indicators; here we consider only the impact of depletion of non renewable resources.

#### 5. Why does it matter?

Avoiding the future potential impacts of depleting resources today is a fundamental element of the definition of sustainability itself. Today's needs should be met while not compromising the ability of future generations to meet their needs.

#### 6. What do I have to check, take into account in my supply chain?

Use of metals, mineral or oil-based materials will contribute to this category of impact as will use of energy from non-renewable fossil sources.

#### 7. When do I have to use/select/consider this indicator?

It may be particularly relevant to consider this indicator to help detect areas of potential concern where emphasis on other factors may lead to burden shifting – either between or within systems. Or in situations where it is expected that different resources used may be an issue. For example: a switch from renewable to non-renewable resources or vice versa.

#### 8. How specific can I interpret the resulting indicator?

There is as yet no consensus on the best way

to assess this impact category. In part, this is because the impacts from depletion of one resource may be rather different from depletion of another. Irreversible depletion of a relatively rare fossil resource presents different considerations than marginal depletion of an abundant elemental resource that can perhaps be recovered at some later date. The indicators above take different approaches, each has its strengths and weaknesses, and each is based on certain assumptions or hypotheses.

Both indicator approaches given here relate in some way a measure of resource use to availability. The CML approach is based on extraction rates and total reserves using antimony as a reference. The method is considered relatively robust but the environmental relevance of 'ultimate reserves' can be questioned. Conversely the EDIP method uses a base of economically available reserves, which can be seen to be more environmentally relevant. The drawback being that economically available reserves vary with fluctuations in market prices and uncertainty is increased. Interpretation, therefore, has to be performed with care.

### 9. How can I reduce uncertainty & evaluate the significance of an impact?

A separate accounting of, on one hand fossil based, and on the other metals and minerals may improve the significance and interpretation of the indicator results. If resource depletion is significant in a packaging system under study and not correlated to the other indicators that have been selected, other approaches may help to discover additional aspects. More conservative approaches on inventory side include indicators based on physical material properties e.g. weight, volume or energy content. More sophisticated (endpoint related) approaches include those relying on surplus energy or surplus cost.

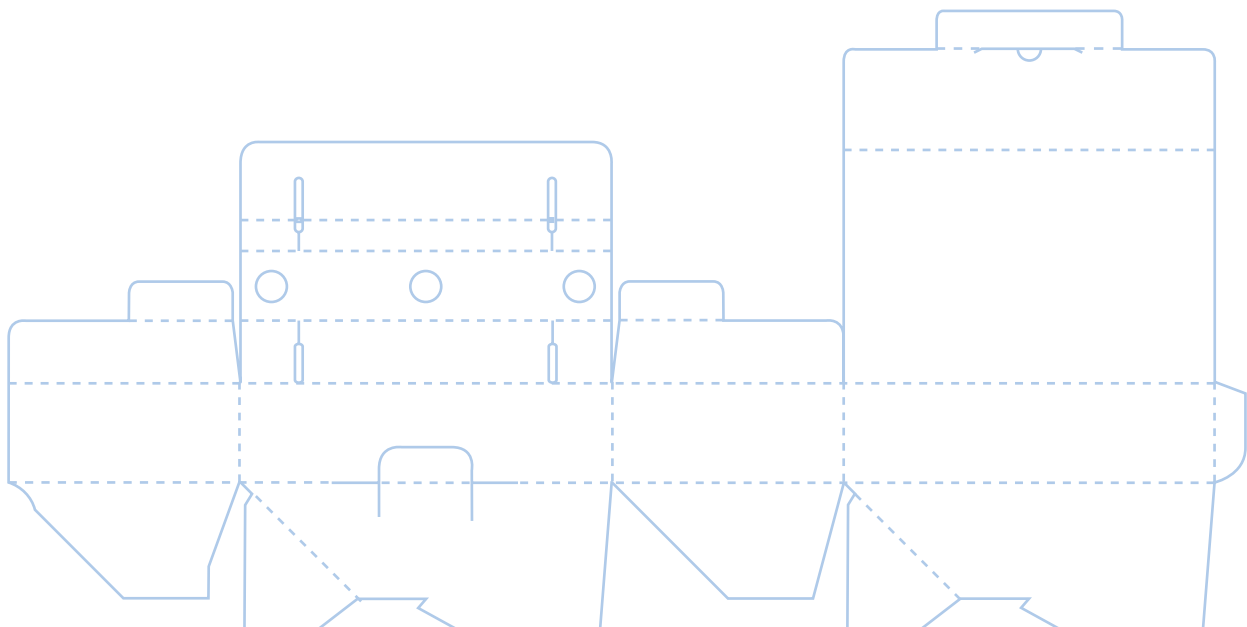

### 10. Who to ask, where to look?

LCA software tools often include the ability to look at non-renewable or abiotic resource depletion, sometimes differentiated at the level of fossil resource and mineral depletion. Consult the relevant software documentation.

Other relevant references include:

- Hauschild, M., Goedkoop, M., Guinée, J., Heijungs, R., Huijbregts, M., Jolliet, O., Margni, M., de Schryver, A., and Bersani, R. (2008). Analysis of existing LCIA methodologies and related approaches. Deliverable 1 of the project: Definition of recommended life cycle impact assessment (LCIA) framework, methods and factors (B1.6). EC-JRC, Ispra.
- Guinée, J.B. (Ed.), Gorrée, M., Heijungs, R., Huppes, G., Kleijn, R., de Koning, A., Van Oers, L., Wegener Sleeswijk, A., Suh, S., Udo de Haes, H.A, De Bruijn, J.A., Van Duin R., Huijbregts, M.A.J. (2002). Handbook on Life Cycle Assessment: Operational Guide to the ISO Standards. Series: Eco-efficiency in industry and science. Kluwer Academic Publishers. Dordrecht (Hardbound, ISBN 1-4020-0228-9; Paperback, ISBN 1-4020-0557-1).
- Hauschild, M.Z. and Wenzel, H. (1998a). Environmental assessment of product. Vol. 2 -Scientific background, Chapman & Hall, United Kingdom, Kluwer Academic Publishers, ISBN 0412 80810 2, Hingham, MA., USA. (2004 update figures <http://www.lca-center.dk/cms/site.aspx?p=1378>)

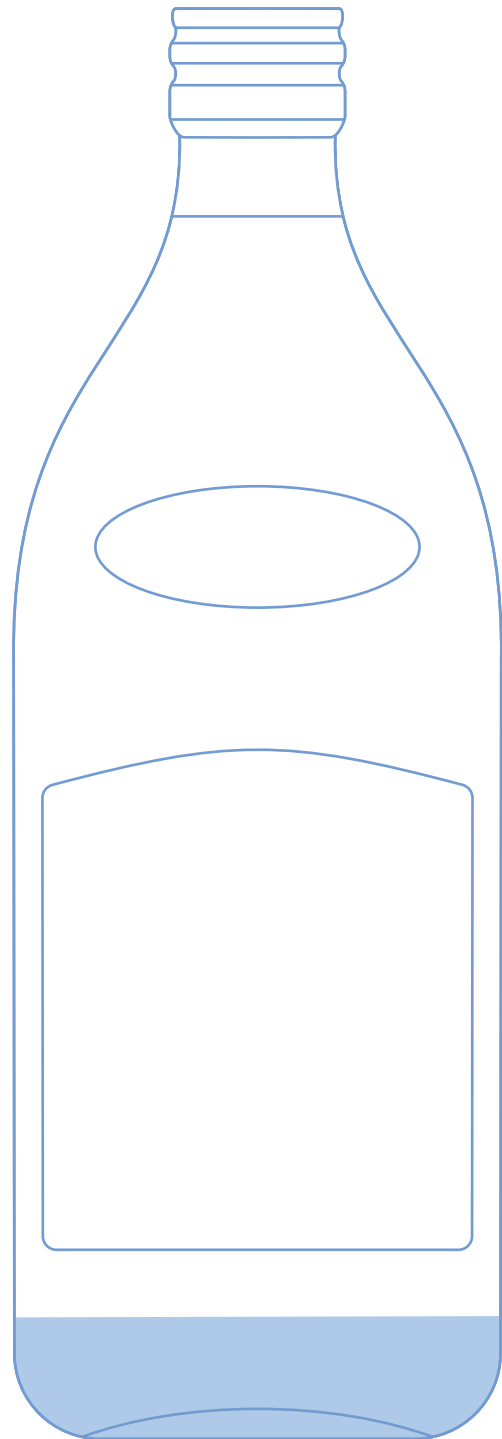



## Indicators from Inventory Data

### Introduction

The life cycle inventory summarizes inputs and outputs on the basis of the reference flows in the system considered. Inventory indicators do not directly represent environmental impacts, although some, such as cumulative energy demand, frequently correlate reasonably well with environmental impact categories.

### Cumulative Energy Demand (CED)

#### 1. Definition

Cumulative Energy Demand is a statement of the entire energy demand for a given product or service. CED covers all sources of energy used for energy generation purposes as well as all energy carriers used for non-energy use, i.e. as materials, sometimes also referred to as feedstock energy.

CED can be divided into two main categories:  $CED_R$  (renewable) and  $CED_{NR}$  (non-renewable). The non-renewable<sup>10</sup> category is comprised by e.g. hard coal, natural gas, crude oil, uranium, whereas the renewable counterpart is represented by, e.g. biomass, wind, solar, geothermal and hydropower.

#### 2. Metric

$CED = CED_R + CED_{NR}$  [MJ/FU] as calculated according to single issue methodologies available in conventional software such as SimaPro, MiLCA(Japan), and GaBi.

#### 3. Who/What at the end am I damaging?

CED is an indirect representation of the depletion of energy carrying natural resources expressed in energy units. The earth contains a finite amount of non-renewable and renew-

able resources which can both be depleted if they are exploited at higher rates than their renewal rate. The extraction and use of energy carrying resources also has impacts on Human Health and Natural Environment and other aspects of Natural Resources such as land use.

#### 4. How does it damage?

In terms of resource use, the end point is assessed as the future consequences of resource extraction, i.e. that the extraction of greater amounts of a given resource today will reduce their availability for future generations.

#### 5. Why does it matter?

The extraction and use of resources for energy generation is acknowledged as a major contributor to a wide range of environmental impact categories. In particular, non-renewable CED has historically been used as a proxy indicator for other environmental impact categories in life cycle assessment screening studies, and it has found to correlate reasonably well to certain impact categories for certain processes such as transportation, and material manufacturing, but the correlation is not consistent across impact categories, processes and regions and should thus not be taken for granted.

#### 6. What do I have to check, take into account in my supply chain?

All resources and processes used to generate energy should be accounted for, also resources which are not consumed, but only contained in the materials (embodied or feedstock energy). It is important to verify that the data used for the energy sources and energy production

<sup>10</sup> Unsustainably managed primary forest is also considered as a non-renewable resource but can currently not be accounted for in available assessment methods for CED.

technology used are representative of the regions where extraction and production occur and that methodology used to account for each energy source and technology is consistent between regions and life cycle steps.

**7. When do I have to use/select/consider this indicator?**

A switch from non-renewable to renewable resources used in packaging materials will logically also lead to a switch of burden from CED non-renewable to CED renewable. As the total amount of energy used in a system is one key criterion and overall it is desirable to use less energy, the use of both renewable and non-renewable CED is advised if energy is included in the assessment. To be meaningful and allow interpretation, a global CED value should thus always be reported together with the breakdown in terms of CED renewable and CED non-renewable. This will not only allow accounting for potential burden shifting, but also ensure that systems with lower overall energy consumption (i.e. higher energy efficiency) can be appropriately evaluated.

**8. How specific can I interpret the resulting indicator?**

Major uncertainties arise from various approaches in characterizing different energy sources such as nuclear power for which various approaches exist. Hard coal can also vary considerably in energy content from one geographical location to another and the data available in LCA databases may not be representative of the coal used in a particular region. In the renewable CED categories there are also unresolved

issues in terms of how the energy content of energy carriers should be accounted for.

**9. How can I reduce uncertainty & evaluate the significance of an impact?**

In a comparison between two alternatives it is crucial to ensure that the same methodology is used to account for CED for both scenarios, in particular when nuclear, coal or hydropower is used, where results will be sensitive to methodological choices as well as, for coal, to local variations in energy content.

**10. Who to ask, where to look?**

LCA tools such as GaBi, MiLCA (Japan) and SimaPro offer a possibility to make CED calculations as an additional single issue calculation which can be added to the evaluation of impacts according to more comprehensive methods such as Impact 2002+, ReCiPe, LIME2 etc.

**Protocols and references**

- VDI-4600 Cumulative Energy Demand: Terms, Definitions, Methods of Calculation, 1997.
- N. Jungbluth, et al., "Cumulative Energy Demand", in Implementation of Life Cycle Impact Assessment Methods, R. Hischier, B. Weidema (eds), Ecoinvent-Report No. 3 (2009).
- R. Frischknecht, R. Heijungs, P. Hofstetter, "Einstein's Lessons for Energy Accounting in LCA", Int. J. LCA, 3(5) 266-272 (1998).

## Freshwater Consumption

### 1. Definition

Methodologies for the measurement and assessment of life cycle impacts related to water resources are currently under development within the scientific community as well as in international initiatives, such as the UNEP/SETAC Life Cycle Initiative (<http://lcinitiative.unep.fr>), and standardization bodies such as ISO which is currently working on the international standard ISO/WD 14046 Water footprint—Requirements and guidelines. Due to the ongoing development, it is premature to recommend life cycle impact assessment methods for freshwater use. We therefore recommend to measure net water consumption (also called “consumptive use”) on an inventory level. Aggregating different measures of water, such as in-stream water use (e.g. turbinated river water for hydro power generation), off-stream use (e.g. cooling water that is returned to the same watershed) or degradative use (e.g. water pollution) at an inventory level would not generate useful decision support and they are therefore excluded from this indicator awaiting the acceptance of a relevant impact assessment method.

Therefore, the water consumption indicator in the GPP indicator and metrics system reflects the water that is incorporated into a product, water that is evaporated in a process, water contained in solid residuals and water that is withdrawn and returned in a different watershed, therefore decreasing the amount of available fresh water in the watershed where the process takes place.

While the definition covers all different levels

of water consumption, users of GPPS can also narrow the metric to certain consumptive uses of water (subsets) as long as the scope is clearly documented and communicated. This flexibility is introduced due to the fact that the scientific debate concerning how to account for water consumption and use on an inventory level is still evolving and the availability of data is also limited.

Focusing on the basic life cycle inventory data for water consumption as explained above will allow for better usefulness and longevity of the reported information as assessment methods mature. Within the inventory, it is advised to distinguish to the extent possible the source of water for the inputs (e.g., river, groundwater, etc.) and also the sinks for the outputs. Information on location within the inventory is increasingly important in evaluating the relative importance or impact of water use and consumption. These additional data points will be the basis to apply impact assessment methods in the future.

### 2. Metrics

Inventory data are measured as a volume (e.g., m<sup>3</sup>) of fresh water consumed per functional unit [m<sup>3</sup>/FU].

### 3. Who/What at the end am I damaging?

Water is essential to sustain life. Although renewable in many cases, water is locally and temporally a finite resource. As such, fresh water needs for industrial, agricultural and domestic purposes may raise situations of competition and overutilization, with detrimental

impacts on the environment and the local communities. Examples can be found in many areas of the world (e.g. Lake Aral).

#### 4. How does it damage?

The consumption of water limits the ability of the environment or human society to use this resource. In some parts of the world the overall needs for water are in good balance with the water availability in that region, and no situation of competition exists. Conversely, in other regions, where water is relatively scarce, consumption of water can significantly affect other users and / or the environment. Such situations of imbalance are expected to increase as a consequence of climate change, population growth and lifestyle changes.

#### 5. Why does it matter?

Water is essential to human health and ecosystem quality. Lack of or limited access to fresh water can result in detrimental hygiene conditions, resulting in the spread of diseases, and water shortages for irrigation or ingestion, resulting in malnutrition. Similarly, ecosystems like wetlands, which present a considerable plant and fauna diversity, would not be able to fulfill their ecological functions without sufficient water input.

#### 6. What do I have to check, take into account in my supply chain?

Agriculture is by far the largest consumer of water. Packaging material sourced from agricultural feedstock might thus score higher on fresh water consumption, especially if they rely on irrigation. Further, waste recovery activities

such as recycling might have larger water consumption scores than alternative treatments if the end-of-life material requires washing after collection.

#### 7. When do I have to use/select/consider this indicator?

Water is rapidly becoming one of the indicators most requested by stakeholders. The selection of the water consumption indicator is especially recommended if the packaging material presents a high content of biogenic raw materials derived from agricultural feedstock. Water consumption may merit deeper consideration and investigation where parts of a supply chain operate in areas that are under water stress or water scarcity.

#### 8. How specific can I interpret the resulting indicator?

The water consumption inventory refers to the aggregated water consumption only, but does not address the local aspect of water sourcing. For instance, it does not differentiate the impacts related to water withdrawal from a water-stressed vs. water-abundant areas. An inventory indicator of water consumption by itself is therefore not adequate to assess impact on water resources from a sustainability perspective. While some impact assessment methods that provide greater relevance are available and under further development, they are as yet in a preliminary stage and often rely on an understanding of the geography of the inventory that is in many cases limited. It should further be noted that existing inventory data from life cycle inventory databases is often in-

complete and inconsistent in its treatment and quantification of water. The water consumption indicator should therefore be treated and interpreted with caution.

**9. How can I reduce uncertainty & evaluate the significance of an impact?**

Accounting for the geography of water consumption, water sources, sinks for the return to the environment (e.g. source, watershed) and quality of the returned water, significantly improves the ability to assess and interpret the relevance of results. A practical approach for instance would be to focus on water consumption inventory data from facilities or operations that are located in areas that are water stressed or scarce.

**10. Who to ask, where to look?**

The ReCiPe handbook contains only a generic chapter on water consumption. The reader is further referred to the Water Footprint Network Website ([www.waterfootprint.org](http://www.waterfootprint.org)) for more information on the emerging water footprint methodologies for measuring use and consumption. The UNEP – SETAC working group on water use in LCA (see <http://lcinitiative.unep.fr/>) and the ISO working group on the accounting and impact modeling for water in LCA are recommended as additional information source.

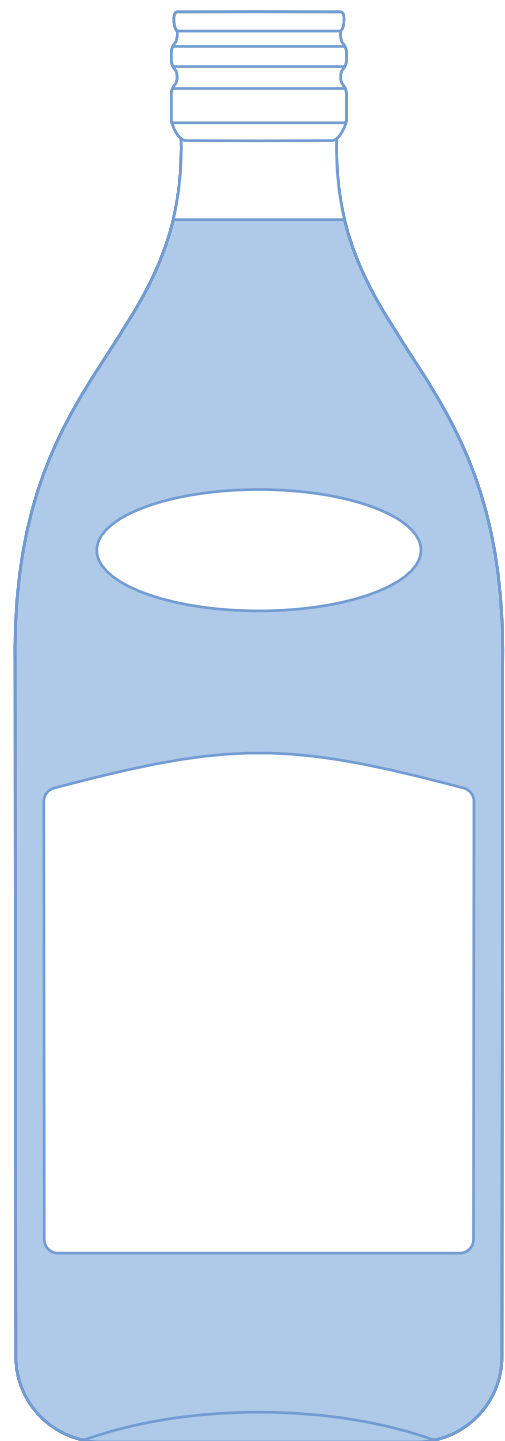

## Land Use

### 1. Definition

The area of land occupied for a certain period of time over the life cycle providing the functional unit

### 2. Metric

[m<sup>2</sup> × years / FU] calculated as the sum of all elementary flows of the type land occupation at inventory level.

### 3. Who/What at the end am I damaging?

Land occupation and transformation can have effects on, for example biotic production potential, biodiversity and ecological soil quality. The safeguard objects are the natural environment and natural resources.

### 4. How does it damage?

Changing or transforming land use - building roads where none were before, intensifying agricultural practices, converting forest to pasture - has direct physical as well as often chemical impacts on the soil and therefore its fertility or production potential. Similarly, ecosystems, habitats and species face direct as well as often indirect effects with changes in land use. Further, by using, or occupying, land for a particular purpose (farming, mining, building, transporting) other uses are denied, at least for a period of time. In order then to determine the environmental impacts from land use it is necessary to know for what activity the land is used and the time during which it is used for that particular purpose. Complexity is added due to the fact that not all damages are fully recoverable after occupation and other aspects like fragmentation of ecosystems are not

linked in a linear fashion to occupation or to transformation.

### 5. Why does it matter?

Land transformation and occupation are closely linked to many impacts categories such as biodiversity, climate change, soil erosion, agricultural and ecosystem productivity, fresh water availability etc.

Use of land is therefore an important element in relation to sustainability. Some of the potential impacts such as releases to water (like fertilizers) or emissions to air (by agricultural equipment) are captured by other impact categories. However, the potential impacts of land use on biodiversity and soil quality are not. These impacts can be of high importance globally as well as locally and are taken seriously in most of the known sustainable development schemes. It is therefore proposed here to use a crude occupation indicator using m<sup>2</sup> × years to flag such potential impacts and concerns, at least until scientific consensus is reached on appropriate approaches and factors to better characterize these important effects.

### 6. What do I have to check, take into account in my supply chain?

A first check should be made to determine if the land use involved in the product system is sufficiently documented to allow a consistent evaluation of occupation and transformation. If this is not the case additional efforts may be justified to improve the knowledge base to support this indicator. Given the packaging supply chain land use can be of major importance

in view of sourcing agricultural raw materials to produce packaging. For minerals and fossil fuels in the direct packaging materials supply chain (foreground-system) the amount of land being used relative to the assessed product may be relevant which has to be checked by case. For transportation, recycling and manufacturing land use may not deliver additional useful information. Where land-filling is practiced to a larger extent, the end of life phase has to be considered in this context as well.

**7. When do I have to use/select/consider this indicator?**

It may be particularly relevant to consider this indicator to help detect areas of potential concern where emphasis on other factors may lead to burden shifting – either between or within systems. It is also useful in situations where it is expected that land use may be an issue. For example: a switch from renewable to non-renewable resources used in packaging materials can lead to an increase in land occupation as agricultural practices and forestry occupies larger surfaces per unit of material produced. In energy generation, coal strip mining can be

a major contributor to an increase in land use.

A simple indicator for land use that does not specify the industrial activity performed on the occupied land and the duration of this activity is running is a very weak indicator of environmental impacts.

**8. How specific can I interpret the resulting indicator?**

By itself, the area of land occupied and transformed (i.e. without supporting information on the change in land quality) is not a reliable indicator of environmental impact. For example, a nature reserve and an industrial production site might occupy the same land surface, but the environmental consequences of that occupation will be considerably different.

Due to the complexity in impacts and cause – effect relationships an aggregation and interpretation of different land uses across the whole life cycle may not give additional insights. Therefore any interpretation needs to be balanced with other indicators and in view of the limitations of the methodologies involved.

**9. How can I reduce uncertainty & evaluate the significance of an impact?**

The indicator, land use is based on a physical measure of surface area and therefore in principle should have a relatively low uncertainty. In practice data is not always available in existing data bases and, where data is present the quality is variable. Different hypotheses or assumptions made with respect to the required surface for a particular activity can lead to disparate figures from different sources.

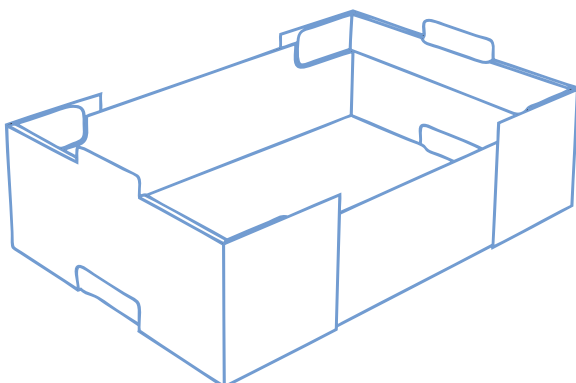

When it comes to assessing impacts, although impact assessment methods exist for land use, the scientific community agrees that these need to be submitted to extensive testing and characterization factors with regional / local relevance need to be developed before any conclusions can be drawn as to the reliability of the assessment method.

In practice the land use indicator can be used as a 'flag' indicating areas of potential concern which can perhaps best be investigated by means other than LCA.

#### 10. Who to ask, where to look?

Land use in terms of occupation and transformation is increasingly measured and readily available in life cycle inventories for many processes.

Impact assessment methods for land use are available in several impact assessment methodologies readily available in LCA software:

- ReCiPe (land occupation & land conversion) <http://www.lcia-recipe.net>
- S. Humbert et al., IMPACT 2002+: User Guide Draft for version 2.1 (land occupation expressed as m<sup>2</sup> Organic arable land eq × year PDF.m<sup>2</sup>.yr. <http://www.syntonie.net/pub/impact/>
- LIME2 (<http://lca-forum.org/database/impact/>)
- The UNEP/SETAC working group 'Operational Characterization Factors for Land use Impacts on Biodiversity and Ecosystem Services (<http://lcinitiative.unep.fr/>) is a recommended source for additional information.

Other useful references include:

- Milà i Canals, L., Bauer, C., Depestele, J., Dubreuil, A., Knuchel, R.F., Gaillard, G., Michelsen, O., Müller-Wenk, R. and Rydgren, B. (2007a). Key elements in a framework for land use impact assessment within LCA. *International Journal of Life Cycle Assessment* 12(1): 5-15
- Köllner & Scholz 2007a Köllner T. and Scholz R. (2007a) Assessment of land use impact on the natural environment: Part 1: An Analytical Framework for Pure Land Occupation and Land Use Change. In: *Int J LCA*, 12(1), pp. 16-23, retrieved from: <http://dx.doi.org/10.1065/lca2006.12.292.1>.
- Köllner & Scholz 2007b Köllner T. and Scholz R. (2007b) Assessment of land use impact on the natural environment: Part 2: Generic characterization factors for local species diversity in Central Europe. In: *Int J LCA*, 13(1) 2008, pp. 32-48.



## References: Environmental Life Cycle Indicators / Metrics

### Climate Change:

- IPCC 2007, Fourth Assessment Report([http://www.ipcc.ch/publications\\_and\\_data/ar4/syr/en/contents.html](http://www.ipcc.ch/publications_and_data/ar4/syr/en/contents.html) )
- The Greenhouse Gas Protocol Initiative, World Resources Institute / World Business Council for Sustainable Development (<http://www.ghgprotocol.org/>)

### Ozone Depletion:

- WMO 1990 factors (ozone depletion)
- LOTOS-EUROS (ozone) (<http://www.lotos-euros.nl/>)

### Human Toxicity:

- USEtox Consensus Model: (<http://www.usetox.org/>) Rosenbaum et al., "USEtox—the UNEP-SETAC toxicity model: recommended characterisation factors for human toxicity and freshwater ecotoxicity in life cycle impact assessment", *Int J Life Cycle Assess* (2008) 13:532–546

### Ionizing Radiation:

- Frischknecht et al., "Human health damages due to ionising radiation in life cycle impact assessment", *Environmental Impact Assessment Review*, 20 (2), April 2000, pp. 159-189.

### Acidification Potential & Aquatic Eutrophication:

#### Accumulated Exceedance / EUTREND

- M. Posch, J. Seppälä, J.-P. Hettelingh, M. Johansson, Manuele Margni and Olivier Jolliet "The role of atmospheric dispersion models and ecosystem sensitivity in the determination of characterisation factors for acidifying and eutrophying emissions in LCIA", *Int J LCA*(2008) 13:477–486
- J. Seppälä, M. Posch, M. Johansson and J.-P. Hettelingh, " Country-Dependent Characterisation Factors for Acidification and Terrestrial Eutrophication Based on Accumulated Exceedance as an Impact Category Indicator", *Int J LCA* 11 (6) 403 – 416 (2006)

### Non-Renewable Resource Consumption:

- Hauschild, M., Goedkoop, M., Guinée, J., Heijungs, R., Huijbregts, M., Jolliet, O., Margni, M., de Schryver, A., and Bersani, R. (2008). Analysis of existing LCIA methodologies and related approaches. Deliverable 1 of the project: Definition of recommended life cycle impact assessment (LCIA) framework, methods and factors (B1.6). EC-JRC, Ispra.

- Guinée, J.B. (Ed.), Gorrée, M., Heijungs, R., Huppes, G., Kleijn, R., de Koning, A., Van Oers, L., Wegener Sleeswijk, A., Suh, S., Udo de Haes, H.A, De Bruijn, J.A., Van Duin R., Huijbregts, M.A.J. (2002). Handbook on Life Cycle Assessment: Operational Guide to the ISO Standards. Series: Eco-efficiency in industry and science. Kluwer Academic Publishers. Dordrecht (Hardbound, ISBN 1-4020-0228-9; Paperback, ISBN 1-4020-0557-1).
- Hauschild, M.Z. and Wenzel, H. (1998a). Environmental assessment of product. Vol. 2 -Scientific background, Chapman & Hall, United Kingdom, Kluwer Academic Publishers, ISBN 0412 80810 2, Hingham, MA., USA. (2004 update figures <http://www.lca-center.dk/cms/site.aspx?p=1378>)

#### Land Use:

- ReCiPe (land occupation & land conversion) <http://www.lcia-recipe.net>
- S. Humbert et al., IMPACT 2002+: User Guide Draft for version 2.1 (land occupation expressed as  $m^2$  Organic arable land eq  $\times$  year PDF. $m^2$ .yr. <http://www.sph.umich.edu/riskcenter/jolliet/impact2002+.htm>
- LIME2 (<http://lca-forum.org/database/impact/>)
- UNEP/SETAC working group "Operational Characterization Factors for Land use Impacts on Biodiversity and Ecosystem Services" <http://lcinitiative.unep.fr/>
- Milà i Canals, L., Bauer, C., Depestele, J., Dubreuil, A., Knuchel, R.F., Gaillard, G., Michelsen, O., Müller-Wenk, R. and Rydgren, B. (2007a). Key elements in a framework for land use impact assessment within LCA. International Journal of Life Cycle Assessment 12(1): 5-15
- Köllner & Scholz 2007a Köllner T. and Scholz R. (2007a) Assessment of land use impact on the natural environment: Part 1: An Analytical Framework for Pure Land Occupation and Land Use Change. In: Int J LCA, 12(1), pp. 16-23, retrieved from: <http://dx.doi.org/10.1065/lca2006.12.292.1>.
- Köllner & Scholz 2007b Köllner T. and Scholz R. (2007b) Assessment of land use impact on the natural environment: Part 2: Generic characterization factors for local species diversity in Central Europe. In: Int J LCA, 13(1) 2008, pp. 32-48.

#### Cumulative Energy Demand:

- VDI-4600 Cumulative Energy Demand: Terms, Definitions, Methods of Calculation, 1997.
- N. Jungbluth, et al., "Cumulative Energy Demand", in Implementation of Life Cycle Impact Assessment Methods, R. Hischier, B. Weidema (eds), Ecoinvent-Report No. 3 (2009).

- R. Frischknecht, R. Heijungs, P. Hofstetter, "Einstein's Lessons for Energy Accounting in LCA", Int. J. LCA, 3(5) 266-272 (1998).

Life Cycle Impact Assessment Methodologies:

- ReCiPe (<http://www.lcia-recipe.net/> )
- IMPACT 2002+ (<http://www.sph.umich.edu/riskcenter/jolliet/impact2002+.htm> )
- TRACI (<http://www.epa.gov/nrmrl/std/sab/traci/> )
- LIME2: (<http://lca-forum.org/database/impact/>)
- EDIP2003: M. Z. Hauschild and J. Potting "Spatial differentiation in life cycle impact assessment - the EDIP-2003 methodology." Guidelines from the Danish EPA, 2004.

## Economic – Indicators / Metrics

### Introduction

Economic indicators and metrics allow us to: 1) understand if and how packaging is meeting marketplace performance and sustainability expectations while controlling costs; and 2) track overall operating efficiency. Packaging that meets environmental and social criteria for sustainability but is cost prohibitive or fails to meet marketplace performance expectations is not sustainable. Therefore, it is important to track packaging cost and performance as a critical market check and balance against the other packaging sustainability criteria and to facilitate understanding of an organization's overall operating efficiency and value creation. However, due to issues related to competition and anti-trust laws, cost measurement data that may be collected in accordance with the indicators and metrics provided in this framework may not be appropriate for sharing with supply chain partners, with customers or in external reports.

### Total Cost of Packaging

#### Definition

The total cost of all materials, energy, equipment and direct labor used during the sourcing of raw, recycled and reused materials and the production, filling, transport and/or disposal<sup>11</sup> of packaging materials, packaging components or units of packaging.

#### Metric

Cost per functional unit of final packaging material, packaging components, packaging or time.

#### Examples

- \$ / kilograms of final packaging material
- € / 1000 units of packaging
- € / year based on production rate

#### What to Measure

Measure the cost of all materials, the direct and indirect cost of energy, the direct cost of equipment and the direct cost of all human resources used during the growth, harvest or extraction and processing of raw materials, processing of recycled or reused materials, production of final packaging materials, conversion of final packaging materials into packaging components, assembly of final packaging components into units of packaging, filing of packaging units, transport of raw, recycled, reused or final packaging materials, packaging components or units of packaging and end-of-life processing of packaging. Direct labor costs should be calculated as “fully loaded” costs — not just wages or salary. Measurement should include facility and equipment operating and main-

<sup>11</sup> Depending on local, regional or national policies, regulations and legislation pertaining to waste management, organizations may not currently track the cost associated with disposal of the packaging they produce or use. Organizations that do not track this cost now should consider tracking it in the future. All organizations should be transparent as to whether disposal costs are or are not included in the total cost of packaging and how disposal cost data is collected.

tenance costs that are directly related to the packaging processes specified here. Energy and utility costs associated with shipping and receiving operations should be proportionally allocated by volume of packaging and volume of product if both are handled within one facility. If packaging is warehoused, include all costs associated with the warehouse facility. Include waste disposal costs, compliance costs and cost of research that is directly related to the resources and processes specified here.

#### What Not to Measure

Do not include any indirect labor costs. An example of indirect labor cost would include but not be limited to cost of sales personnel. Do not include facility operating overhead that is not directly related to the processes specified here. Do not include cost of handling or transporting packaging that contains product.

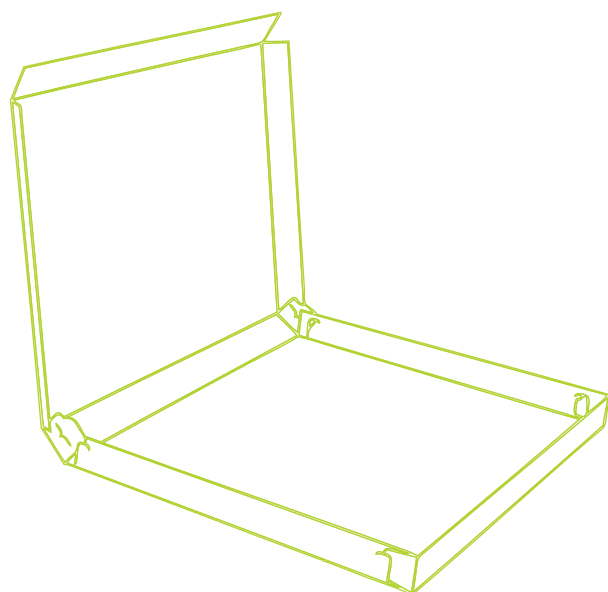

## Packaged Product Wastage

### Definition

To assess if you have found the balance between overpackaging versus underpackaging by reporting the monetary value lost in wasted goods during distribution and product use .

### Metric

Cost of wasted goods expressed as a percentage of cost of goods sold per annum.

### Examples

- $100 \times \$ \text{ of wasted goods} / \$ \text{ of goods sold per annum}$

### What to Measure

Calculate the total cost of a unit of sales packaging. Add that cost to the stated value of the lost or returned product. Include the cost of primary and secondary packaging.

### What Not to Measure

Do not include the cost of transport packaging unless there is bulk product loss due to failure at the transport system level.

## Social – Indicators / Metrics

### Introduction

The social indicators and metrics allow to, 1) understand how workers across the supply chain are treated; and 2) track progress toward ensuring equitable, safe and healthy working conditions for all workers. Stakeholders from consumer groups to social investment managers are increasingly interested in the social performance of organizations, particularly regarding labor practices. Stakeholders' interests do not end at corporate boundaries but continue across global supply chains. The increased focus on corporate social responsibility over the last decade has helped to improve working conditions around the globe, yet inequitable, unsafe and unhealthy working conditions still exist. Measuring worker benefits and impacts across the supply chain is an important risk management strategy that can help protect an organization's corporate image and brand reputation while improving the quality of life for all workers.

### Packaged Product Shelf Life

#### Definition

The ratio of a product's shelf life in packaging to a product's shelf life without packaging.

#### Metric

Shelf life of product in packaging divided by shelf life of product without packaging.

#### Example

- $\text{Months in packaging} \div \text{months without packaging}$

#### What to Measure

This metric only applies to products with a defined shelf-life or pot-life such as food & drink, paints, medication etc.

Measure the length of time a product in packaging is suitable for sale compared to a product not in packaging. Compare only same product types in same packaging types.

#### What Not to Measure

This metric does not apply to products which do not have a clearly defined shelf life. For such products the economic indicator Packaged Product Wastage is recommended. Do not take and compare measures of different types of products in the same types of packaging or of same types of products in different types of packaging.

### Community Investment

#### Definition

The value of investments made in community projects related to packaging such as recycling education programs or recycling infrastructure development over and above regulated requirements.

#### Metric

- $\text{Percentage of turnover of business operations dedicated to supporting community projects related to packaging.}$

#### Example

$\text{Monetary value of investment} / \text{Annual turnover} [\%]$

#### What to Measure

Measure contributions given to or investments made in any/all packaging-related community project(s). Include a description of the project(s) supported.

#### What Not to Measure

Do not include contributions given to or investments made in any community project that is not packaging-related.

## Corporate Performance Attributes

Beyond the quantifiable and quantitative metrics included in the Protocol, organizations may be interested in communicating about other aspects of their operational performance that may not be limited to packaging operations. These enterprise-level criteria address broad management and workplace practices. The checklist below provides a simple tool to facilitate collection of this information from supply chain partners.

### Instructions

The criteria are based on the Global Social Compliance Program (GSCP) (see [www.gscpnet.com](http://www.gscpnet.com)) which can be used by companies as a reference against which to compare their existing requirements. Please list the GSCP standard, or equivalent national law or standard, on which the policy is based. If the policy is audited, please identify the type of audit (internal or 3rd party) geographic region of relevance, and provide documentation as appropriate. Provide additional comments as desired. The attributes relate to the presence of internal policies and procedures related to the attributes and the compliance of such policies with external standards or regulations.

Criteria	Yes	No	Standard/Law on which Policy Based	Audit process	Additional Comments
<b>ENVIRONMENTAL</b>					
Environmental Management System compliant with ISO 14001, EMAS or equivalent is in place					
Energy Audits/reviews are conducted annually					
<b>SOCIAL</b>					
Child Labor					
Excessive Working Hours					
Responsible Workplace Practices					
Forced or Compulsory Labor					
Remuneration					
Freedom of Association and/or Collective Bargaining					
Occupational Health					
Discrimination					
Safety Performance Standards					

Table 3. General corporate performance attributes.

### References: Social – Indicators / Metrics

- ISO 14001:2004 Environmental Management Systems – Requirements with Guidance for Use
- ISO 14004:2004 Environmental Management Systems – General Guidelines on Principles, Systems and Support Techniques
- ISO 19011:2002 Guidelines for Quality and/or Environmental Management Systems Auditing
- US - OSHA Standards, US Department of Labor, Occupational Health & Safety Administration.
- EU – OSHA Standards, European Agency for Safety & Health at Work.
- International Labour Standards, International Labour Organisation (ILO) (<http://www.ilo.org/>)
- SA8000:2008 Workplace Standard, Social Accountability International (<http://www.sa-intl.org/>).



## Annex 1: Cube Utilization - Protocols for Product Volume (PV)

Product Form	Product Volume Definition	Example
Liquid	label volume If product is labeled by weight use $\frac{\text{label weight}}{\text{density}}$	A 12 fluid ounce soft drink has a product volume of 12 fluid ounces or 21.7 in <sup>3</sup> .
Flowable Solids: Labeled by Weight - e.g. powders, granules, tablets	$\frac{\text{label weight}}{\text{settled bulk density}}$ Settled bulk density is the bulk density of the product as it sits on the shelf.	A 5kg bag of sugar (with a bulk density of .849 g/cm <sup>3</sup> ) has a product volume of 5,889 cm <sup>3</sup> or 359.4 in <sup>3</sup>
Flowable Solids: Labeled by Count	count x $(\frac{\text{average volume}}{\text{Known count}})$	A 50ct bottle of tablets (where 1000 tablets require 1000 cm <sup>3</sup> ) has a product volume of 50 cm <sup>3</sup> or 3.1 in <sup>3</sup> .
Product sold by surface area: Non-compressible (e.g. films, wrapping paper)	Total surface area x thickness [thickness is the average thickness of the product as it sits on the shelf]	A 100 ft roll of aluminum foil that is 12 in wide and 0.02 in thick has a product volume of 288 in <sup>3</sup> .
Products sold by surface area: Compressible products.	Compressible products sold on rolls, like paper towels, may have different thickness from inside to outside of the roll. In this case use the volume of the roll minus the volume of the core. In both cases volume is calculated as a cylinder. Compressible products like tissues or quick clean sheets use volume as in the package (not allowed to expand outside of package).	A roll of toilet paper that is 4 in high and 5 in diameter with a 1.3 in outside diameter core has a product volume of 73.2 in <sup>3</sup> . $4 \times (\frac{\pi \times 5^2}{4} - \frac{\pi \times 1.3^2}{4})$ A stack of sheets is 3 in x 4 in x 5 in the carton. Product volume is 60 in <sup>3</sup> i.e. (3 x 4 x 5).
Products sold by length (e.g. floss, hose, rope)	Cross sectional area x length [calculate cross sectional area as the smaller of a circle or rectangle. If cross sectional area varies, determine volume for each section with a uniform cross sectional area and add the volumes for a total volume. If product has continuous variation in cross section, use an average value.]	A hose that has a 1 in outer diameter for 50 ft plus a fitting on one end that is 1 in long and 1.5 in diameter, has a volume of 473 in <sup>3</sup> . $(50 \times 12 \times \frac{\pi \times 1^2}{4}) + (1 \times \frac{\pi \times 1.5^2}{4})$
Single Object	Smallest volume (rectangular solid, cylinder, sphere or triangular solid) the object will fit into as packaged (not in the final assembled state).	A TV with outer dimensions 50 in x 10 in x 30 in has a product volume of 15,000 in <sup>3</sup> .
Multiple Objects: Bulk Packed [packed together without separate packaging for each object.]	$\frac{\text{label weight}}{\text{settled bulk density}}$ or Smallest volume (rectangular solid, cylinder, sphere or triangular solid) the objects will fit into as packaged (not in the final assembled state).	A tub of various building blocks fits into a cylinder with a diameter of 10 in and a height of 20 in. The product volume is 785 in <sup>3</sup> .
Multiple Objects: Individually Packed	Sum of individual object volumes.	Three figurines are sold in one package. They fit into cylinders with volumes of 125 in <sup>3</sup> , 100 in <sup>3</sup> , and 200 in <sup>3</sup> . The product volume is 425 in <sup>3</sup> .
Multiple Objects: Nested	If an object nests with or fits inside another object as it sits on the shelf, determine the volume as though they are a single object.	A stack of 25 cups fits into a cylinder with a diameter of 4 in and a height of 12 in. The product volume is 151 in <sup>3</sup> . $\frac{\pi \times 4^2}{4} \times 12$
Other	Smallest volume (rectangular solid, cylinder, sphere or triangular solid) the product will fit into.	

